

User Manual

LCD monitor

Model: ST-HB65AV SERIES



Contents

IMPORTANT SAFETY INSTRUCTIONS	3
SAFETY PRECAUTIONS	3
INSTALLATION (WHEN INSTALLING THE MONITOR, PLEASE FOLLOW THE INSTRUCTIONS IN THE MANUAL)	4
USE	5
CLEANING	6
WARNING FOR USE	6
USE	6
EXEMPTIONS	6
FEATURES	7
PACKAGE CONTENTS	7
DIMENSIONS	10
POWER INPUT	11
POWER INTERFACE	11
SIGNAL SOURCE INPUT	12
OPERATING THE MONITOR	13
THE SIDE CONTROLLER OF THE MONITOR	13
THE REMOTE CONTROL (RCU) INSTRUCTIONS	15
CHANGE THE RCU BATTERY	16
DISPLAY MODE	17
OSD (ON SCREEN DISPLAY) MENU FUNCTION	20
ON-SCREEN DISPLAY (OSD)	24
DEFAULT SETTING	32
TOUCH OPERATION (ST-HB65AVT ONLY)	33
SUPPORTED TIMING	35
SPECIFICATION	36
TROUBLESHOOTING	37
COMPLIANCE	37
APPENDIX I	38
APPENDIX II	39
APPENDIX III	41

※ Please read this user's manual thoroughly and completely before operating this monitor.

Important Safety Instructions

Before using the monitor, please read this user's manual thoroughly to help protect against damage to your own and other people's property and ensure your own and other people personal safety.

- ◆ Be sure to observe the following instructions.
- ◆ For your safety, be sure to observe the warnings located in this manual.
- ◆ For installation or adjustment, please follow this manuals instruction and refer all servicing to qualified service personnel.

Safety Precautions

If smoke or peculiar smell comes from the monitor, remove the power plug from the outlet immediately.

Failure to do so may result in fire or electrical shock. Contact your dealer for inspection.

If the monitor has been turned on but there isn't a picture, remove the power plug from the outlet immediately.

Failure to do so may result in fire or electrical shock. Contact your dealer for inspection.

If water is spilled or objects are dropped inside the monitor, remove the power plug from the outlet immediately.

Failure to do so may result in fire or electrical shock. Contact your dealer for inspection.

If the monitor is dropped or the cabinet is damaged, remove the power plug from the outlet immediately.

Failure to do so may result in fire or electrical shock. Contact your dealer for inspection.

To turn off the power of the monitor, press "O" on the main power switch at side of monitor.

The power standby/on indicator will go off and the monitor cannot to be turned on/off by using the POWER button on the remote control. (To turn on/off the monitor by the remote control, press the main power switch again and light the power standby/on indicator.)

- ◆ When turning off the monitor by pressing the POWER button on the remote control, the main power of the monitor is not turned off completely.
- ◆ To disconnect the monitor completely from power supply, remove the power plug from the outlet.

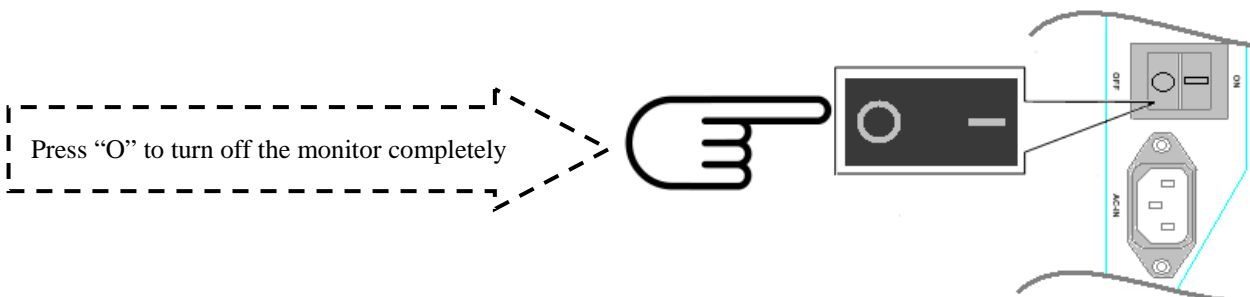

If the power cord or plug is damaged or becomes hot, turn off the main power switch of the monitor, make sure the power plug has cooled down and remove the power plug from the outlet.

If the monitor is still used in this condition, it may cause a fire or an electrical shock. Contact your dealer for replacement.

Installation (when installing the monitor, please follow the instructions in the manual)

Don't install in a high-temperature environment.

If the monitor is used in high-temperature or in direct sunlight, it may cause the case or other parts become distorted or damaged resulting in overheating or electric shock.

Don't install in a high-humidity environment.

This may cause overheating or electric shock.

Don't install near any heat sources such as radiators, heat registers, stoves, or other apparatus that produce heat.

This may cause a fire or electric shock.

Don't overload outlets or cables beyond electrical capacity.

Don't use extension cords as it may cause a fire or electric shock.

Don't insert the power plug into an outlet other than 100~240V AC.

This may cause a fire or electric shock.

- ◆ Don't use a damaged power plug or worn outlet.
- ◆ Don't insert the improper power plug it may cause a fire and electric shock.

Don't place the monitor on an unstable shelf or surface.

The monitor may fall causing injury. Please install on a horizontal, stable, level surface.

Don't place objects on the monitor.

- ◆ If the monitor is covered or the vents are blocked, the monitor could overheat and cause a fire.
- ◆ If metal or liquid gets into the monitor, it may cause a fire or an electrical shock.
- ◆ Do not put heavy objects on the monitor as it may fall causing injury.
- ◆ Please keep a 10cm minimum distance between the monitor and the wall for sufficient ventilation.

Don't move the monitor when it is connected to the power cord and AV cables.

- ◆ When moving the monitor, make sure to remove the power plug and cables from the outlet or source.
- ◆ When unpacking or carrying the monitor, at least 2 people are needed. Make sure the monitor is carried upright.
- ◆ Transport the monitor upright. Avoid placing the monitor face up or down.
- ◆ Handle the monitor gently. Do not drop.

If you encounter a problem during installation, please contact your dealer for assistance. Don't repair or open the monitor by yourself.

Failure to do so may result in fire or electrical shock. Contact your dealer for inspection.

Protect and correctly use the power cord/plug.

- ◆ Don't press heavily on the power cord/plug.
- ◆ Don't step on the power cord/plug.
- ◆ Before inserting the power plug into the wall outlet, connect the power cord to the monitor.
- ◆ Don't operate the monitor with a damaged power cord or it may damage the monitor.

Using the extension cords (not recommended)

If an extension cord must be used, ensure the voltage rating exceeds the max power consumption of the monitor, if the voltage rating is less than the monitor, it will cause the extension cord to overheat.

If there is thunder or lightning, don't touch the monitor or the power plug.

This may cause an electric shock.

Don't use any kind of liquid on the monitor.

- ◆ If liquid is spilled on the monitor, remove the power and ask a qualified service personnel to check the monitor.
- ◆ If the liquid get's on the monitor's screen, please clean it with a dry and soft cloth immediately.
- ◆ Don't use any harsh chemical on the monitor.
- ◆ If metal or liquid gets into the monitor, it may cause a fire or an electrical shock.

Don't install or remove the power plug with wet hands.

This may cause an electric shock.

If the monitor will not be used for a long period of time, unplug the monitor.

This may cause premature wear of electrical components or fire.

Don't press on the LCD panel.

This may cause personnel injury or panel damage.

Don't push or shake the monitor.

This may cause damage or injury.

- ◆ If the glass of the monitor panel is broken, liquid may escape. Please don't touch the liquid.
- ◆ If liquid get into your eyes or touches your skin, wash with the clean water and seek medical attention immediately.

Precautions with the remote control batteries.

- ◆ Please only use approved AAA type batteries.
- ◆ Please be sure to insert batteries by matching the + and -.
- ◆ Don't recharge, heat, disassemble, short or throw batteries into a fire.
- ◆ Don't mix a new battery with a used one.
- ◆ Don't mix different types of batteries together (only use the specified type). Or, it may cause burn and injury.

Cleaning

If dust has collected on the power plug, removed the plug from the outlet and clean off the dust.

Dust build-up may cause a fire.

Take off the power plug before cleaning.

Failure to do so may result in electrical shock or damage.

Cleaning the surface of the monitor.

- ◆ When the surface of the monitor becomes dirty, please wipe the surface lightly with a soft clean cloth.
- ◆ If the surface requires additional cleaning, lightly moisten the cloth with rubbing alcohol.
- ◆ Do not to let alcohol enter the monitor as it may cause electrical shock or damage.

Warning For Use

Use

- ◆ Do not use this “**ST-HB65AVX Series model**” on the ground.
- ◆ If ground usage is necessary, there are 4 screw holes on the stand, please use the M10x20 screws to fix the monitor to the ground.
- ◆ The monitor may overheat during operation. Please be careful.
- ◆ Transport the monitor upright with proper packaging. Avoid placing the monitor face up or down. Be careful not to bump to the monitor.
- ◆ Do not send a static (non moving) image this monitor, or it may cause image ‘burn-in’ or image retention.
- ◆ “Burn in” and/or image retention is not covered under warranty.
- ◆ Make sure to change the image on the monitor periodically. It is recommended to turn off the monitor for at least 6 hours after 18 hours of usage in a day to avoid image retention.

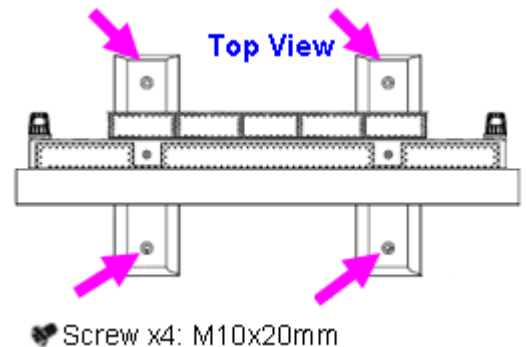

Exemptions

- ◆ This product isn't warranted for any damage caused by natural disaster (such as earthquake, thunder, etc), fire, acts by third parties, accidents, owner's intentional misuse and fault, or uses in other improper conditions.
- ◆ This product isn't warranted for incidental damages (such as profit loss or interruption in business, modification or erasure of record data, etc.) caused by use or inability to use of this product.
- ◆ This product isn't warranted for any damage caused by inappropriate operation, or from not following the user manual.
- ◆ This product isn't warranted for any damage caused by misuse or malfunction through simultaneous use of this product and the connected equipment or software.
- ◆ This product isn't warranted for any damage caused by neglect of the instructions described about installation.
- ◆ This product isn't warranted for any damage caused by improper installation.
- ◆ This product isn't warranted for any damage caused by disassembly, modification or repair by non-authorized service center or people.

Features

High-resolution Full-HD 120Hz panel

This monitor supports a 1920 x 1080 HDTV format and can display true 16.7M colors.

Wide MVA TFT LCD panel with AR coating

Most LCD screens use an anti-glare (AG) treatment on their top surface to diffuse the reflected light from external lighting sources. When light hits this rough surface it bounces off at different angles, which reduces the intensity of light reflecting off of the surface and hitting your eyes. While this reduces the intensity of light, it does, however, leave a hazy image of the reflection and reduces the effective contrast. An LCD with an anti-reflective (AR) coating actually reduces reflected light. Also, because the surface of an anti-reflective LCD has a smooth gloss finish, the image is crystal clear with improved color and has a higher effective contrast in higher ambient light conditions.

Full array of PID connectivity

<u>Video system Input:</u>		<u>RGB Input:</u>	<u>Communication</u>
HDMI	x2	PC (VGA D-Sub 15pin) x1	RS-232C in D-sub 9pin
COMPONENT (RCA)	x1	PC (DVI D-sub 24 pin) x1 (★option)	RS-485 in/out
VIDEO (RCA)	x1		
S-VIDEO (Mini Din 4 pin)	x1		

★option: only available on ST-HB65AA versions

Other functions

- ◆ High color saturation.
- ◆ 2 HDMI v1.3 inputs with HDCP.
- ◆ SPDIF output.
- ◆ Signal source auto detection.
- ◆ OSD keypad lock function.
- ◆ PIP/ PBP function. Please see the chapter “Display mode ”
- ◆ Overscan function.
- ◆ Supports input main / sub source detection.

Package Contents

Unpacking

- ◆ ST-HB65AVX is packed in a carton box and banded to a custom pallet. The ST-HB65AVX is packed using cushions to protect the monitor during shipping.
- ◆ Before unpacking your monitor, prepare a stable, level, and clean surface near a wall outlet.
- ◆ Set the LCD Monitor box in an upright position and open from the top of the box before removing the top cushions.
 - Step 1: Remove the white handle and cut the banding

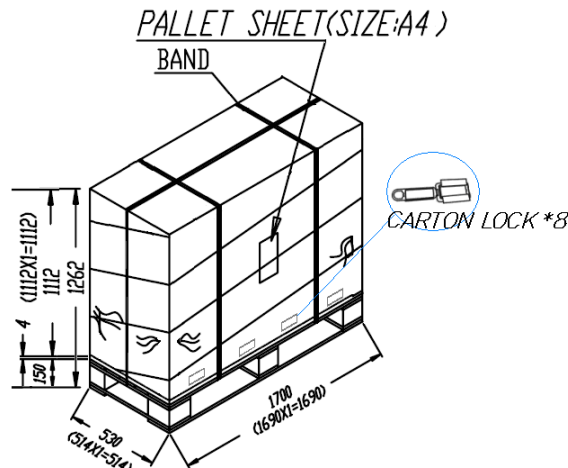

- Step 2: Remove the top cushion and take the accessories Bag out.
- Packing list

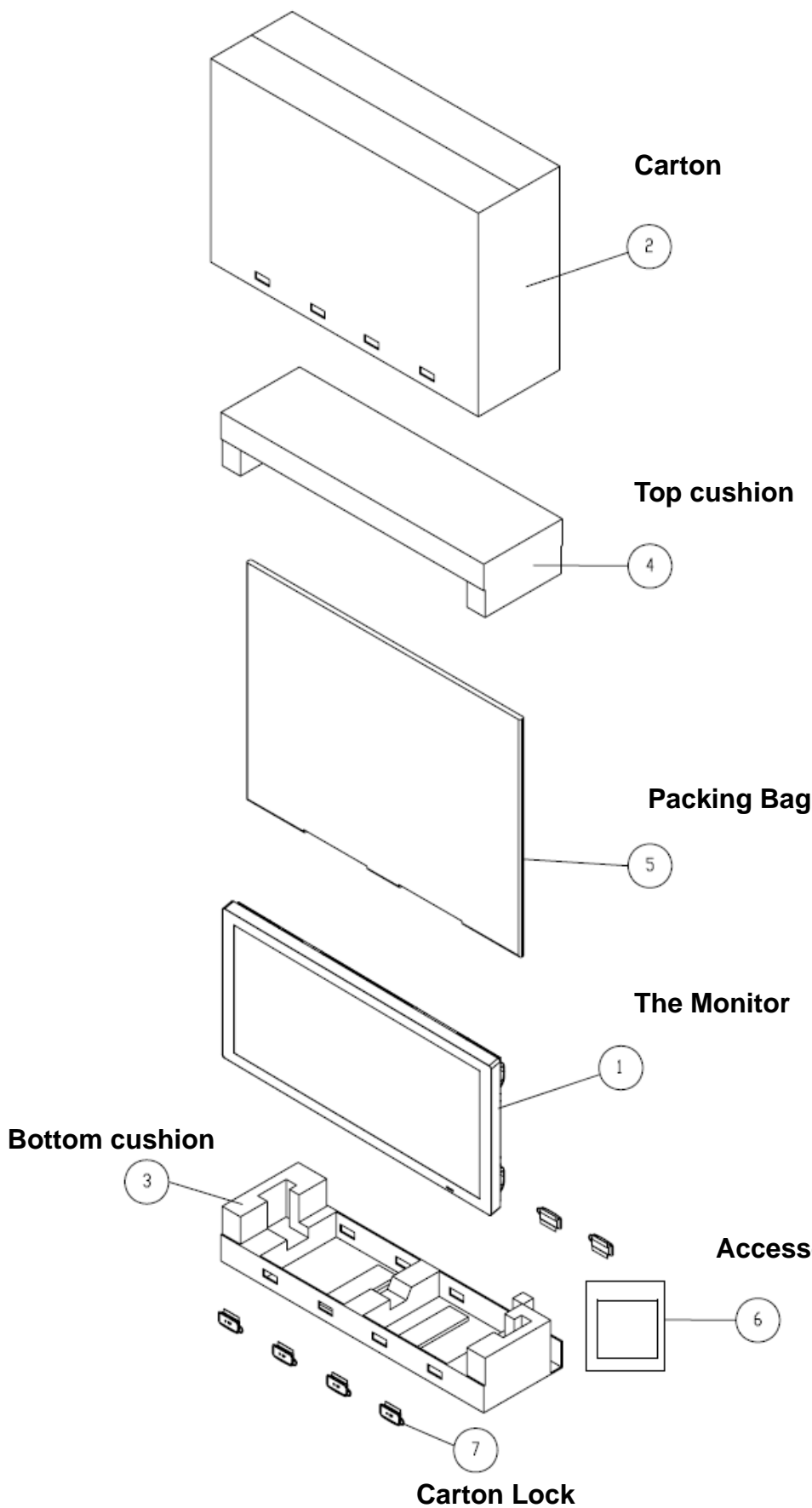

Item		Q'ty
1	ST-HB65AVX	1 set
2	Carton	1 pcs
3	Bottom cushion	1 pcs
4	Top cushion	1 pcs
5	Packing bag	1 pcs
6	Accessories Bag	
	Remote control	1 pcs
	Batteries	2 pcs
	Power cord	1 pcs
7	D-SUB 15pin cable	1 pcs
	Carton lock	8 pcs

Contents of the Accessory Bag

VGA Cable (D-sub)



Power Cord –black



OSD Remote Control

2 piece batteries (AAA) inside.



USB Cable (ST-HB65AVT only)



Dimensions

	A	B
65AVX	88.5mm	155.7mm
65AVT	103.8mm	171mm

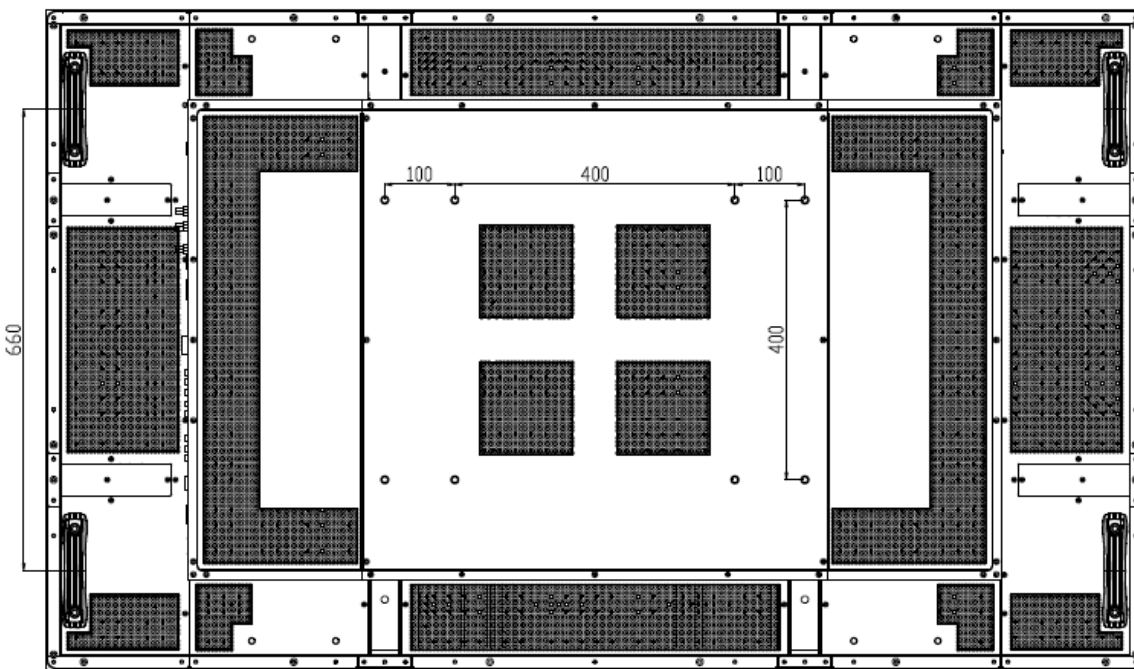
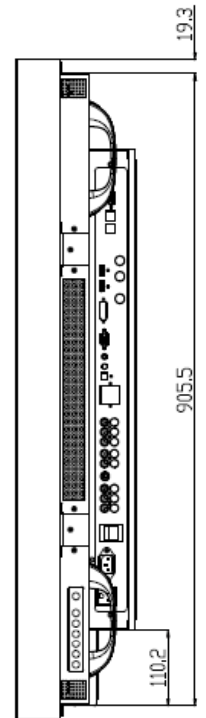
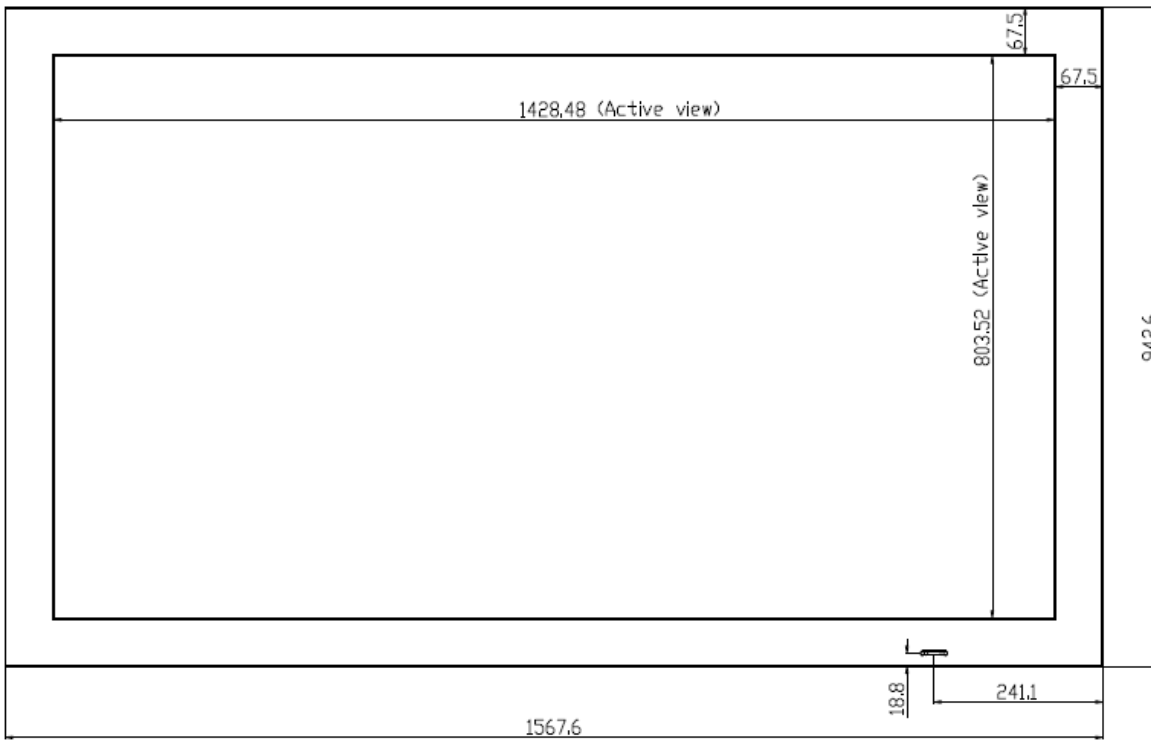
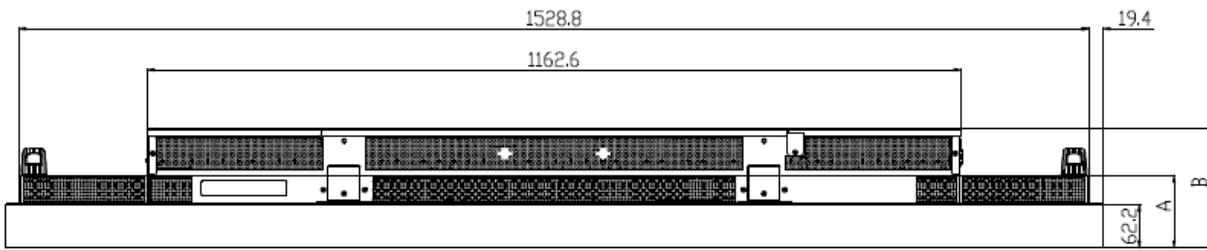

Installation

Environmental state

- ◆ Operating temperature: 5°C ~ 35°C (Fahrenheit : 41°F ~ 95°F)
- ◆ Humidity : 85% RH (Max)

Power Input

Power Cord

The included power cord is used to connect the side controls of the LCD monitor and the wall outlet. Connect the power cord into main power of the monitor, “-” is power on, “O” is power off.

Input: 100-240V~ 3A 50/60Hz

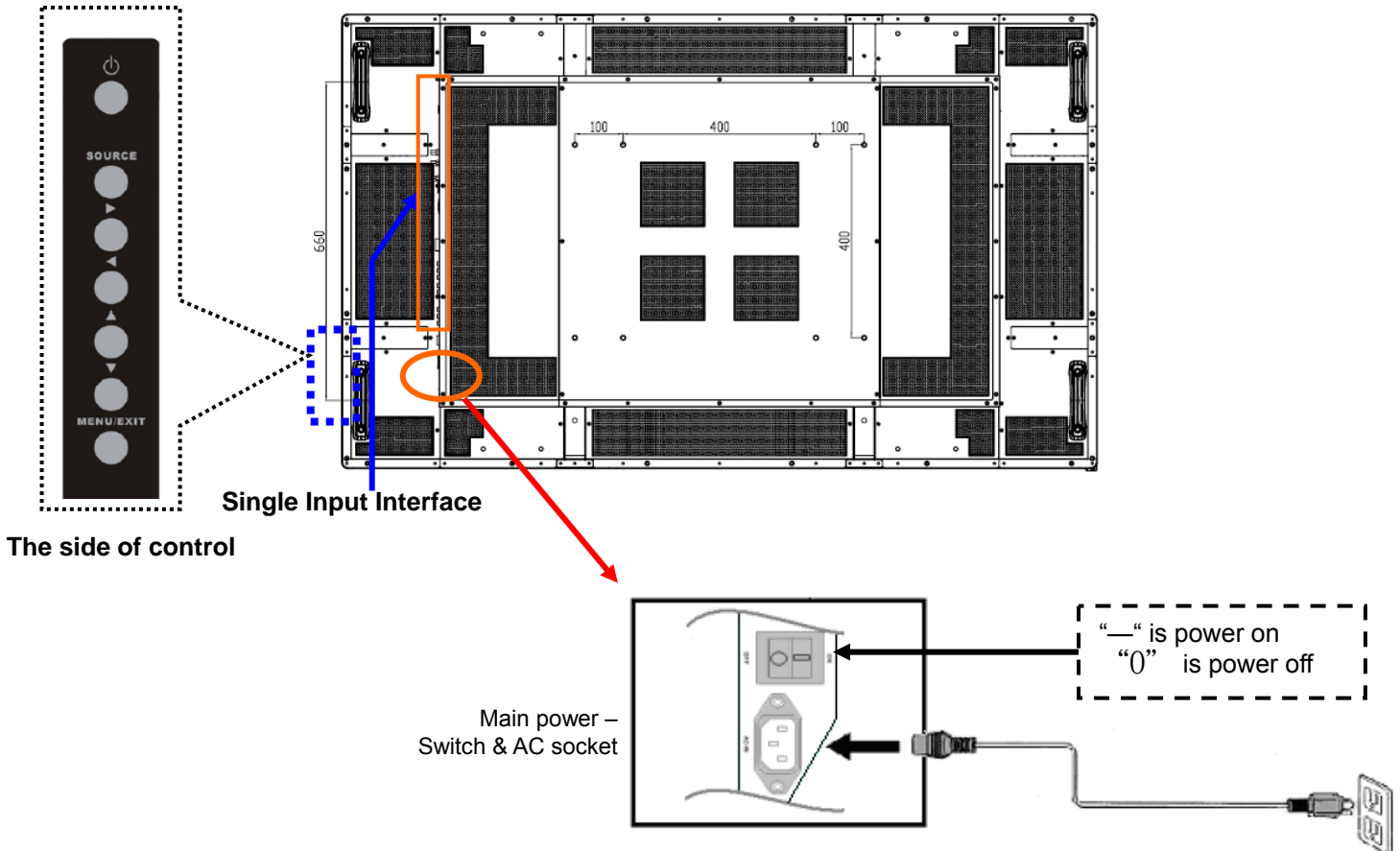

Power Interface

- ◆ Main power - switch & AC socket. Please see the chapter “Power input ”
- ◆ The side controller of the monitor
- ◆ The remote control (RCU)

Signal Source Input

Input Interface

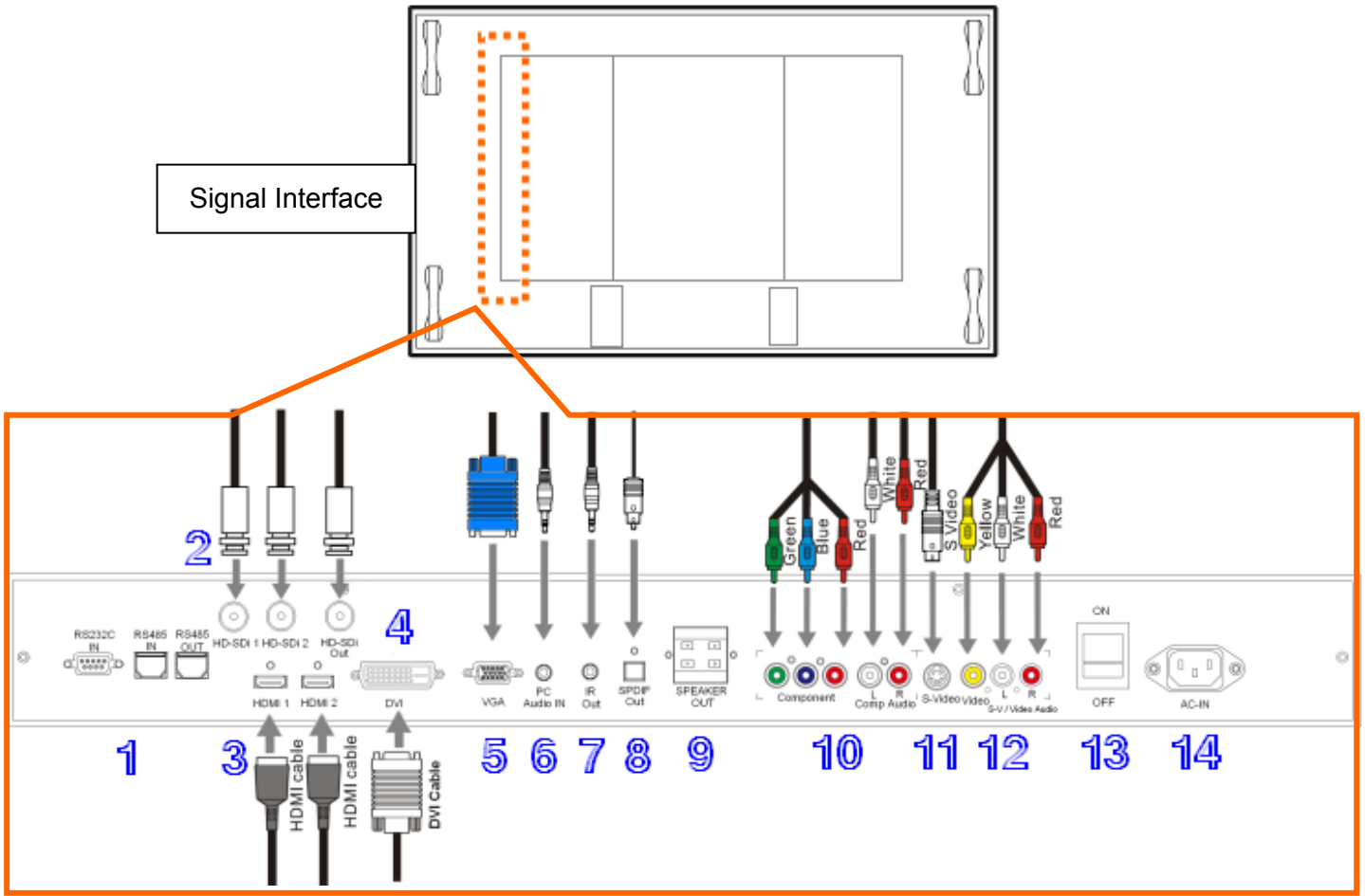

	Name	Connector	Remarks
1	RS232C input x 1	D-Sub 9 pin	
	RS485 input x1	RJ-45	
	RS485 output x1	RJ-45	
2	HD-SDi 1 input x1	BNC	AA version only
	HD-SDi 2 input x1	BNC	
	HD-SDi output x1	BNC	
3	HDMI 1 input x1		
	HDMI 2 input x1		
4	DVI-D input x1	D-Sub 24 pin	AA version only
5	VGA (PC) input x 1	D-Sub 15 pin	
6	PC audio in x1	Mini jack	
7	IR out x1	Mini jack	AA version only
8	SPDIP output x 1		
9	Speaker out L/R x1	Push terminal	AA version only
10	Y-Pb-Pr (Y-Cb-Cr) input x 1	RCA G/B/R	
	Audio for Component input x 1	RCA L/R	
11	S-video input x 1	Mini Din 4 pin	
12	Video input x 1	RCA	
	Audio for S-Video/Video input x 1	RCA L/R	
13	AC switch	ON/OFF	
14	Power cord input	AC input	

Operating The Monitor

The side controller of the monitor

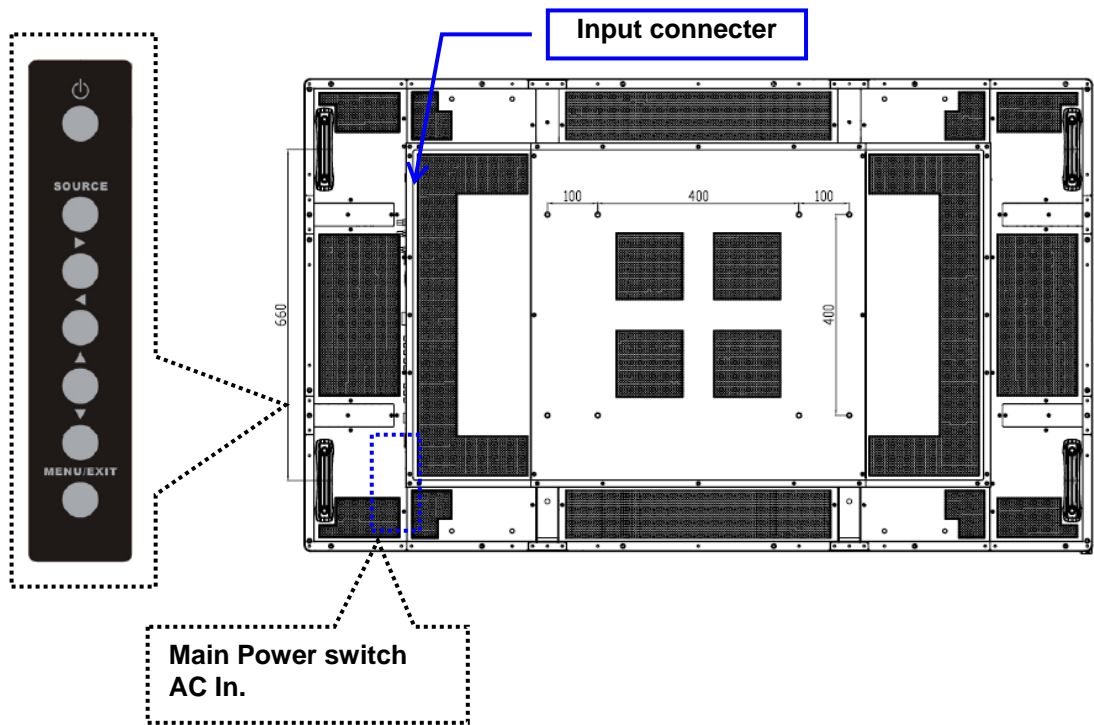

OSD Key Pad function List

Key	Descriptions
Power	Power on/Power off
Source	Source selection (toggle)
▶	Menu Right/Volume +
◀	Menu Left/Volume -
▲	Menu Up
▼	Menu Down
Menu/Exit	Menu/Exit selection



LED ON:

Power Status	Condition
Green	Power On
Orange	Power off
	Power saving mode
	Select LED on via menu (Front LED: On)
Off	AC off
	Power on Select LED on via menu (Front LED: Off)

- Power ON-Stand by Indicator
- Remote Control Receiver

LED OFF:

The LED turns completely off when in the “off” mode regardless of the monitor being on or off.

The Remote Control (RCU) Instructions



No.	Function	Description
1		Turns the monitor on and off
2	INFO	Provides source and resolution information
3	VGA	Selects the PC RGB source
	DVI	Selects the PC DVI source (AA board only)
	HDMI 1	Selects the HDMI source 1
4	COMP 1	Selects the Component source
	AV 1 (VIDEO 1)	Selects the Composite Video source
	HDMI 2	Selects the HDMI source 2
5	COMP 2	Not available at this model
	AV 2 (VIDEO 2)	Not available at this model
	HD-SDi 1	Selects the HD-SDi source 1 (AA board option only)
6	PIP	Turns the PIP feature on and off
	S-V	Selects the S-Video source
	HD-SDi 2	Selects the HD-SDi source 2 (AA board option only)
7	SWAP	Swaps the main source & sub source picture
8	P-SOURCE	Selects the secondary sub-source
9	MENU	Opens the monitor's on-screen menu system. When the menu system is already open, pressing this button will select the previous submenu
		Navigates through submenus and settings
10	EXIT	Closes the menu system
11	ENTER	Selects highlighted menu choices
12	SCALING	Toggles between different aspect ratios (Auto, Native, 4x3, 16x9, 16x10 and Letterbox)
	FREEZE	Freezes the current source image
	MUTE	Turns off the sound
	BRIGHT	Adjusts the brightness
	CONTRAST	Adjusts the contrast
	AUTO	Synchronizes the monitor to the source
	SOURCE	Allows selection of the different sources
	VOLUME-	Decreases the sound volume
VOLUME+	Increases the sound volume	

★ Hot Key : OSD Menu Lock/Unlock Control

Lock: Press **Enter**, **Enter**, **Exit**, **Exit**, **Enter** and **Exit** on the controller by sequence and OSD will be locked.

Unlock: Press **Enter**, **Enter**, **Exit**, **Exit**, **Enter** and **Exit** on the controller by sequence again and OSD will be unlocked.



Change The RCU Battery

Remove the battery cover

1. Slide back and remove the battery cover in the direction of the arrow.

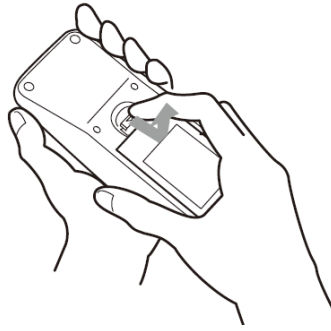

Insert the batteries

2. Align and insert two AAA batteries according to their plus and minus ports (as indicated in the remote control).

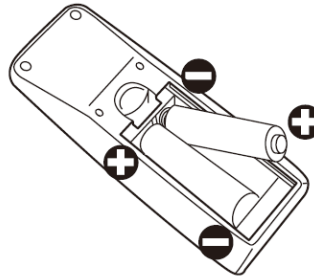

Close the battery cover

3. Replace the battery cover in the direction of the arrow and snap it back into place.

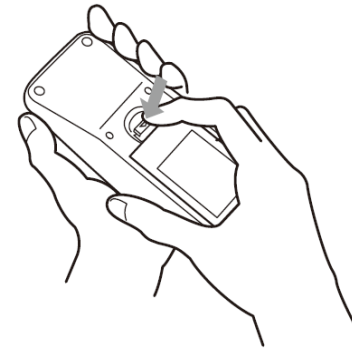

- i. Used batteries needed to follow the city rule to be discarded.
- ii. Avoid keeping used, old batteries inside the remote control, causing leakage of internal liquid resulting metal rust or fatal damage to the remote control hand unit.
- iii. Battery to be used according to the instruction



CAUTION

About the remote control

- ◆ Don't drop, shake or bump.
- ◆ Don't place on wet materials.
- ◆ Don't dismantle.
- ◆ Don't place in locations with exposure to high-temperature or high-humidity levels.

Display Mode

Turning the monitor on

1. Correctly insert the power cord into monitor and into the power outlet.
2. Ensure the AC switch is set to “—”.
3. Press the power button on the remote or side control panel.

Turning the monitor off

With the power on, press the power button on the remote or side control panel to put the monitor in a standby mode. To turn off power completely, turn the AC switch to “O” or disconnect the AC power cord from the power outlet.

Note:

If there is no signal input for a period of time, the monitor will automatically go to standby mode.

Adjusting the Volume

1. Using the remote, press the **VOLUME-** or **VOLUME+** to increase or decrease the volume.
2. Press the **MUTE** button to temporarily turn off all sound. To restore the sound, press the **MUTE** button again.

Selecting the input source

1. Using the remote, press the desired source button (VGA, HDMI1, HDMI2, COMP, VIDEO or S-V)
2. Or press **SOURCE** on the monitor keypad, use the arrow buttons (**▲ ▼**) to navigate to the desired input source, and press **ENTER**:
 - ◆ **HDMI 1**
 - ◆ **HDMI 2**
 - ◆ **VGA**
 - ◆ **Component**
 - ◆ **S-Video**
 - ◆ **Composite Video**
 - ◆ **DVI (AA version only)**
 - ◆ **HD-SDi (AA version option)**
3. When the monitor cannot find a source, a “No signal” message will appear.



PIP mode

1. **Select the main source** – Using the remote, press the desired source button (VGA, HDMI1, HDMI2, COMP, VIDEO or S-V).
2. **Turn on PIP:** Using the remote, press **PIP**.

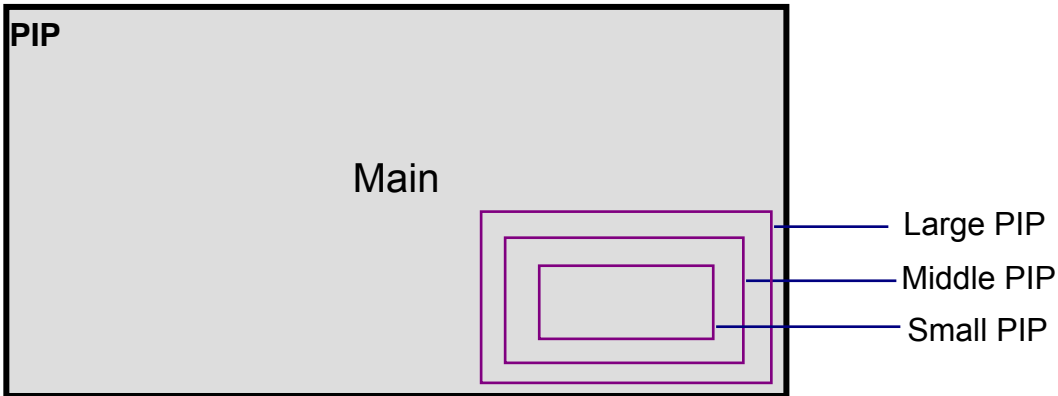

3. **To select the PIP/ sub-source:** Using the remote, press **P-SOURCE** and use the arrow buttons (▲ ▼) to navigate to the desired sub-source. Press **ENTER**.
4. **To change the size and position of the sub-source:** Using the remote, press **P-POSITION** to toggle through the options.

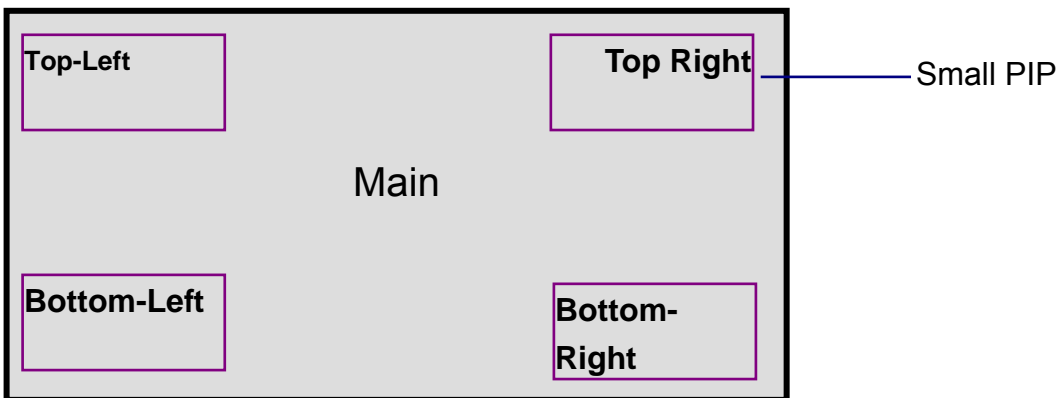

5. **To switch the main source and the subsource:** Using the remote, press **SWAP**.

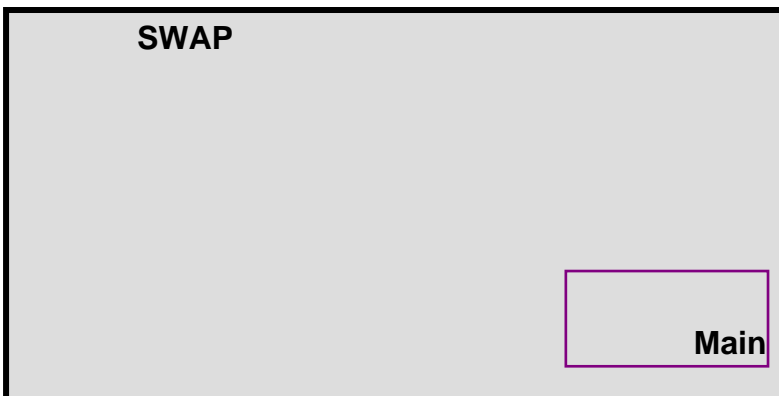

6. **To switch audio between the main source and the subsource:** Using the remote, press **AUDIO**.
7. **Note:** For additional **PIP** functionality, press **MENU** and navigate to the **Display Settings** menu. Use the arrow buttons (▲ ▼) to navigate to the desired **PIP** feature and press **ENTER**. Press ► to toggle through the associated options and press **ENTER** to select the highlighted option.

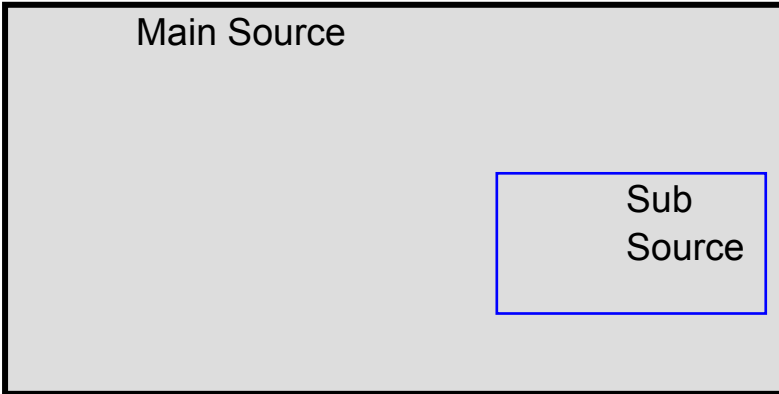

8. **Side by Side (Picture-by-Picture):** Press **P-POSITION** button choose “Side by side” mode, then the main source and the subsource will be on the screen display.

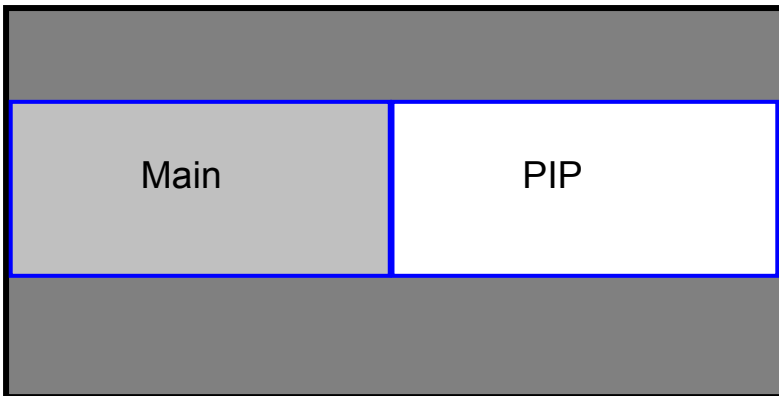

PIP Screen Table

	HDMI 1	HDMI 2	VGA	Component	S-Video	Video
HDMI 1	—	—	Yes	Yes	Yes	Yes
HDMI 2	—	—	Yes	Yes	Yes	Yes
VGA	Yes	Yes	—	Yes	Yes	Yes
Component	Yes	Yes	Yes	—	Yes	Yes
S-Video	Yes	Yes	Yes	Yes	—	Yes
Video	Yes	Yes	Yes	Yes	Yes	—

OSD (On Screen Display) Menu Function

Graphics Mode

Main Menu	Sub-Menu	Sub-Sub menu	Description	Setting	
Image Settings	Scheme		Disabled in Graphics mode		
	Brightness		Adjust the brightness of the screen	0~100	
	Contrast		Adjust the contrast of the screen	0~100	
	Sharpness		Adjust the sharpness of the screen	0~24	
	Saturation		Disabled in Graphics mode		
	Hue		Disabled in Graphics mode		
	Backlight		Adjust the backlight	0~255	
	Gamma & Color Temp	Gamma	Select the Gamma	2.2, Off	
		Color Temp	Select the Color Temp	5000K ,6500K,7500K, 9300K,User	
		Red Gain	Select the Red Gain	128 ~ 384	
Green Gain		Select the Green Gain	128 ~ 384		
Blue Gain		Select the Blue Gain	128 ~ 384		
Red Offset		Select the Red Offset	-50 ~ 50		
Green Offset		Select the Green Offset	-50 ~ 50		
Blue Offset	Select the Blue Offset	-50 ~ 50			
Display Settings	Main	Aspect Ratio	Adjust the aspect ratio of the screen	Full Screen, Native, Letter Box, Pillar Box	
		Zoom	Adjust the zoom function	▶◀	
		Auto Scan	Select the Auto scan function	Off, On	
		Select source	Select the main input source	Video,S-V,Comp VGA,HDMI1/2,DVI (AA board only), SDi 1/2 (AA board option)	
	PIP	PIP mode	Select PIP mode	Off, Large PIP, Medium PIP, Small PIP, Side by Side	
		PIP Position	Select PIP location	Bottom-Right, Top-Left Top-Right, Bottom-Left	
		Aspect Ratio	Adjust the aspect ratio of the screen	Full Screen, Native, Letter Box, Pillar Box	
		Side by Side Scale		▶ PIP ◀ Main ▲ Zoom IN ▼ Zoom Out	
		Auto Scan	Select the Auto scan function	Off, On	
		Select source	Select the main input source When PIP mode is enable	Video,S-V,Comp, VGA,HDMI1/2, DVI (AA board only), SDi1/2 (AA board option)	
		Audio Settings	Volume		Adjust volume
	Bass		Adjust Bass volume	0 ~ 20	
	Treble		Adjust Treble volume	0 ~ 20	
Balance			Adjust the balance of the screen	0 ~ 20	
HDMI Audio Input			SPDIF & audio input Control	HDMI/PC	
Basic Settings	OSD Transparent		Adjust the OSD transparent function	0 ~ 100	
	OSD Location		Adjust the OSD location	▶◀▲▼	
	OSD Zoom		Adjust the OSD size (Disable in portrait type)	Off, On	
	OSD Rotation		Adjust the OSD rotation	0°/90°/180°/270°	
	OSD Language		Select the OSD language	English/ Chinese	
	OSD Timeout		Select the OSD timeout seconds	5~120 sec.	
	Sleep Timer		Select the sleep timer	Off, 15,30,60,90,120 Min.	
Real Time Clock		Setup Date & Time			

Main Menu	Sub-Menu	Sub-Sub menu	Description	Setting
Advanced Settings	Auto Adjustment		Select Auto adjustment function	Off, On
	Image Position		▶ 0~ -100 ◀ 0 ~ 100 ▲ according to resolution ▼ according to resolution	
	Phase		According to resolution	
	Clock		According to resolution	
	Flesh Tone		Disabled in Graphics mode	
	Front LED		Select the front LED function	Off, On
	IRFM		Select the anti burn in mode function	Off, On
	Band rate		Setting the band rate of monitor	115200,38400,19200,9600
	Monitor ID		Setting the ID of monitor	1 ~ 255
	Light Sensor		Select light sensor function	Off, On
Factory Reset		Reset to the factory default setting	Yes, No	
System Status	Channel Information	Source	Show the name of input source	
		Resolution	Show the current resolution	
		Firmware Version	Show the firmware of the monitor	

Video Mode

Main Menu	Sub-Menu	Sub-Sub menu	Description	Setting	
Image Settings	Scheme		Select the scheme	User, Vivid, Cinema, Game Sport	
	Brightness		Adjust the brightness of the screen	0~100	
	Contrast		Adjust the contrast of the screen	0~100	
	Sharpness		Adjust the sharpness of the screen	0~24	
	Saturation		Adjust the saturation of the screen	0~100	
	Hue		Adjust the hue of the screen	0~100	
	Backlight		Adjust the backlight	0~255	
	Color Temp & Gamma	Gamma		Select the Gamma	2.2, Off
		Color Temp		Select the Color Temp	5000K, 6500K, 7500K, 9300K, User
		Red Gain		Select the Red Gain	128 ~ 384
Green Gain		Select the Green Gain	128 ~ 384		
Blue Gain		Select the Blue Gain	128 ~ 384		
Red Offset		Select the Red Offset	-50 ~ 50		
Green Offset		Select the Green Offset	-50 ~ 50		
Blue Offset		Select the Blue Offset	-50 ~ 50		
Display Settings	Main	Aspect Ratio	Adjust the aspect ratio of the screen	Full screen, Pillar Box, Letter Box, Native	
		Zoom	Adjust the zoom function	▶ ◀	
		Auto Scan	Select the Auto scan function	Off, On	
		Select source	Select the main input source	Video, S-V, Comp, VGA, HDMI1/2, DVI, SDI1/2	
	PIP	PIP mode		Select PIP mode	Off, Large PIP, Medium PIP, Small PIP, Side by Side
		PIP Position		Select PIP location	Bottom-Right, Top-Left Top-Right, Bottom-Left
		Aspect Ratio		Adjust the aspect ratio of the screen	Full screen, Pillar Box Letter Box
		Side by Side Scale			▶ PIP
					◀ Main
					▲ Zoom IN ▼ Zoom Out
		Auto Scan		Select the Auto scan function	Off, On
	Select source		Select the main input source When PIP mode is enable	Video, S-V, Comp VGA, HDMI1/2, DVI, SDI1/2	
	Audio Settings	Volume		Adjust volume	0 ~ 100
Bass		Adjust Bass volume	0 ~ 20		
Treble		Adjust Treble volume	0 ~ 20		
Balance		Adjust the balance of the screen	0 ~ 20		
HDMI Audio Input		SPDIF & audio input Control	HDMI/PC		
Basic Settings	OSD Transparent		Adjust the OSD transparent function	0 ~ 100	
	OSD Location		Adjust the OSD location	▶ ◀ ▲ ▼	
	OSD Zoom		Adjust the OSD size (Disable in portrait type)	Off, On	
	OSD Rotation		Adjust the OSD rotation	0°/90°/180°/270°	
	OSD Language		Select the OSD language	English/ Chinese	
	OSD Timeout		Select the OSD timeout seconds	5~120 sec.	
	Sleep Timer		Select the sleep timer	Off, 15, 30, 60, 90, 120 Min.	
Real Time Clock		Setup Date & Time			

Main Menu	Sub-Menu	Sub-Sub menu	Description	Setting
Advanced Settings	Auto Adjustment		Disabled if not a VGA mode	
	Image Position		Disabled if not a VGA mode	
	Phase		Disabled if not a VGA mode	
	Clock		Disabled if not a VGA mode	
	Flesh Tone		Select the flesh tone setting	Off, High, Medium, Low
	Front LED		Select the front LED function	Off, On
	IRFM		Select the anti burn in mode function	Off, On
	Band rate		Setting the band rate of monitor	115200,38400,19200,9600
	Monitor ID		Setting the ID of monitor	1 ~ 255
	Light Sensor		Select light sensor function	Off, On
Factory Reset		Reset to the factory default setting	Yes, No	
System Status	Channel Information	Source	Show the name of input source	
		Resolution	Show the current resolution	
		Firmware Version	Show the firmware of the monitor	

On-Screen Display (OSD)

Menu Overview

Image settings – Main setting

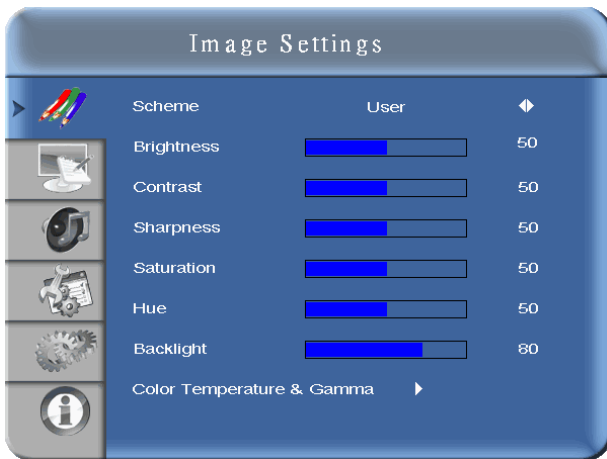









Image Settings

▶		Scheme	User	◄
		Brightness	<input type="range" value="50"/>	50
		Contrast	<input type="range" value="50"/>	50
		Sharpness	<input type="range" value="50"/>	50
		Saturation	<input type="range" value="50"/>	50
		Hue	<input type="range" value="50"/>	50
		Backlight	<input type="range" value="80"/>	80
		Color Temperature & Gamma	▶	

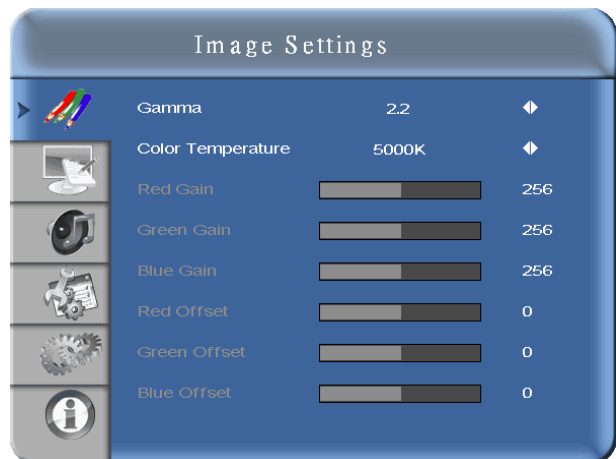







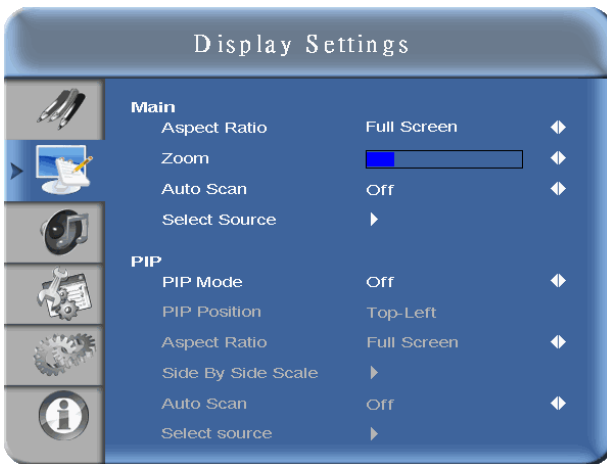







Image Settings

▶		Gamma	2.2	◄
		Color Temperature	5000K	◄
		Red Gain	<input type="range" value="256"/>	256
		Green Gain	<input type="range" value="256"/>	256
		Blue Gain	<input type="range" value="256"/>	256
		Red Offset	<input type="range" value="0"/>	0
		Green Offset	<input type="range" value="0"/>	0
		Blue Offset	<input type="range" value="0"/>	0

Display settings (PIP)







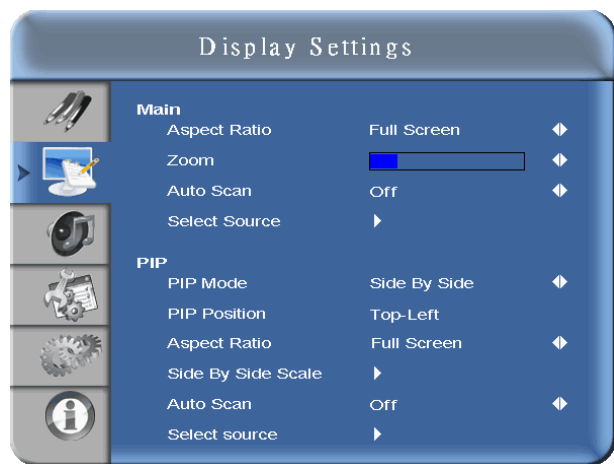

Display Settings

		Main		
		Aspect Ratio	Full Screen	◄
▶		Zoom	<input type="range" value="50"/>	◄
		Auto Scan	Off	◄
		Select Source	▶	
		PIP		
		PIP Mode	Off	◄
		PIP Position	Top-Left	
		Aspect Ratio	Full Screen	◄
		Side By Side Scale	▶	
		Auto Scan	Off	◄
		Select source	▶	







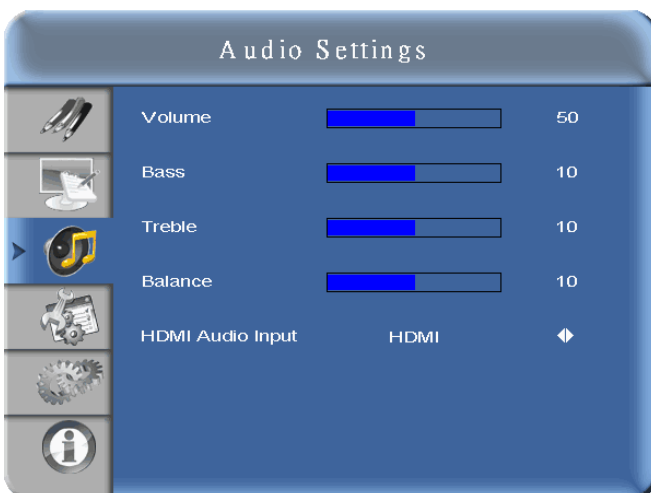

Display Settings

		Main		
		Aspect Ratio	Full Screen	◄
▶		Zoom	<input type="range" value="50"/>	◄
		Auto Scan	Off	◄
		Select Source	▶	
		PIP		
		PIP Mode	Side By Side	◄
		PIP Position	Top-Left	
		Aspect Ratio	Full Screen	◄
		Side By Side Scale	▶	
		Auto Scan	Off	◄
		Select source	▶	

Audio Settings



Audio Settings

		Volume	<input type="range" value="50"/>	50
		Bass	<input type="range" value="10"/>	10
▶		Treble	<input type="range" value="10"/>	10
		Balance	<input type="range" value="10"/>	10
		HDMI Audio Input	HDMI	◄
				
				

Basic Settings

Basic Settings

	OSD Transparent	<input type="text" value="0"/>	0
	OSD Location		
	OSD Zoom	Off	◊
	OSD Rotation	0 degree	◊
	OSD Language	English	◊
	OSD Timeout	30 Sec.	◊
	Sleep Timer	Off	◊
	Real Time Clock	▶	

Advanced Settings

Advanced Settings

	Auto Adjustment	No	
	Image Position	▶	
	Phase	<input type="range" value="50"/>	
	Clocks	<input type="range" value="50"/>	
	Flesh Tone	Off	◊
	Front LED	Off	◊
	IRFM	Off	◊
	Baud Rate	115200	◊
	Monitor ID	0	◊
	Light Sensor	Off	◊
	Factory Reset	No	◊

System Status

System Status

	Channel Information		
		Source	Resolution
	Main	HDMI1	1024x768@60.0Hz
	PIP	VGA	1024x768@60.0Hz
	Firmware Version	V0.01	

Navigating through the Menu System

1. With the power on, press **MENU**. The **Image Settings** menu will display.
2. Within the menu, use **▲**, **▼**, **◀**, **▶**, and **ENTER** to navigate through the menus and adjust options.
3. Press **MENU** to return to the previous menu. To exit the menu system, press **EXIT**.

Image Settings Menu

This menu is used for making common image adjustments.

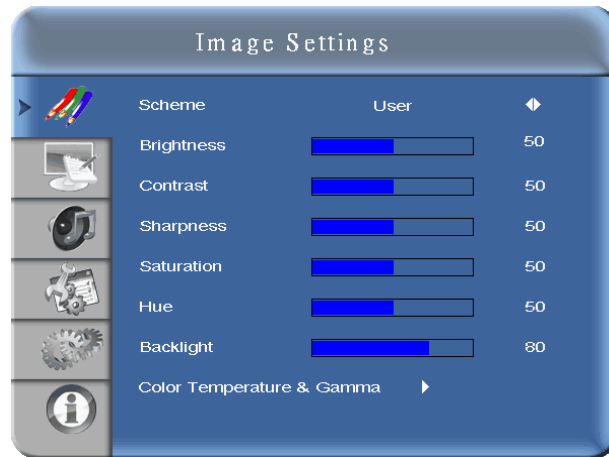

Scheme

Press **◀** or **▶** to select one of the following:
Options: User, Vivid, Cinema, Game, Sport
Default: User

Brightness

Increases or decreases the brightness of picture. Press **◀** or **▶**, select the desired level, and then press **ENTER**.
Range: 0~100; **Default:** 50

Contrast

Increases or decreases the contrast of picture. Press **◀** or **▶**, select the desired level, and then press **ENTER**.
Range: 0~100; **Default:** 50

Sharpness

Adjusts the definition of picture. Press **◀** or **▶**, select the desired level, and then press **ENTER**.
Range: 0~24; **Default:** 10

Saturation

Adjusts the brilliance and brightness (only Video Mode). Press **◀** or **▶**, select the desired level, and then press **ENTER**.
Range: 0~100; **Default:** 50

Hue

Increases or decreases the green hue (Only Video Mode). Press **◀** or **▶**, select the desired level, and then press **ENTER**.
Range: 0~100; **Default:** 50

Back Light

Range: 0~100; **Default:** 80

Color Temp and Gamma

Adjusts red, green, blue gain and red, green blue offset.

Image Settings Menu (continued)

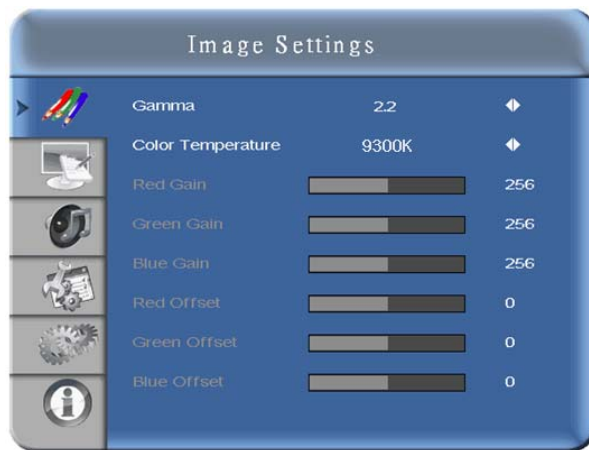

Gamma

Options: Off, 2.2
Default: 2.2

Color Temp

Options: User, 5000K, 6500K, 7500K and 9300K.
Default: 9300K

Red Gain

Set Color Temperature to "User Mode" in order to adjust this setting.
Range: 128~384
Default: 256

Green Gain

Set Color Temperature to "User Mode" in order to adjust this setting.
Range: 128~384
Default: 256

Blue Gain

Set Color Temperature to "User Mode" in order to adjust this setting.
Range: 128~384
Default: 256

Red Offset

Set Color Temperature to "User Mode" in order to adjust this setting.
Range: -50~50
Default: 0

Green Offset

Set Color Temperature to "User Mode" in order to adjust this setting.
Range: -50~50
Default: 0

Blue Offset

Set Color Temperature to "User Mode" in order to adjust this setting.
Range: -50~50
Default: 0

Display Settings Menu

This menu is used for common source adjustments.

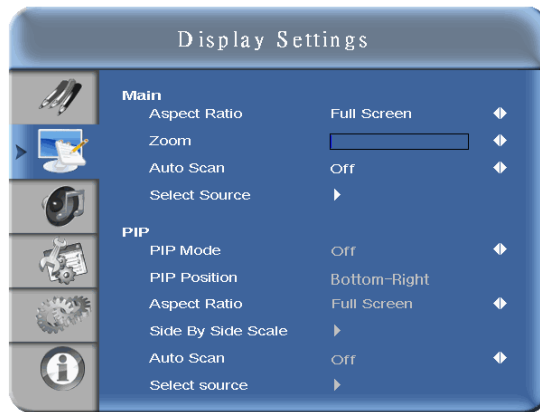

Main

	The Display Setting Mode.
Aspect Ratio	Changes the picture aspect ratio Press ◀, ▶ to select the following options: Options: Full screen, Pillar Box, Letter Box ,Native Default: Full screen
Zoom	Range: 0~10 Default: 0
Auto Scan	Range: On, Off Default: On
Select Source	Options: HDMI1, HDMI2, VGA, Component, S-Video and Video Default: HDMI1

PIP

PIP Mode	Options: Off, Large PIP, Middle PIP, Small PIP and Side-by-Side Default: Off
PIP Position	Options: Bottom-Right, Top-Left, Top-Right and Bottom-Left Default: Bottom-Right
Aspect Ratio	Options: Full screen, Pillar Box, Letter Box Default: Full screen
Side by Side Scale	Submenu Options: Zoom In, Zoom Out, Main, PIP, Default and Return
Auto Scan	Options: On, Off Default: On
Select Source	Options: HDMI1, HDMI2, VGA, Component, S-Video and Video Default: VGA

Audio Settings Menu

This menu is used for adjusting volume settings.

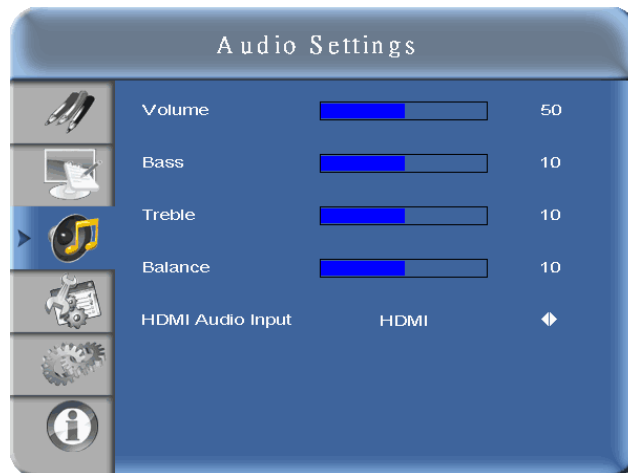

Volume

Adjust the sound. Press ◀ or ▶, select the desired level, and then press **ENTER**.
Range: 0~100
Default: 50

Bass

Adjust the sound in low tones (bass). Press ◀ or ▶, select the desired level, and then press **ENTER**.
Range: 0~20
Default: 10

Treble

Adjust the sound in high tones (Treble). Press ◀ or ▶, select the desired level, and then press **ENTER**.
Range: 0~20
Default: 10

Balance

Adjust the balance of the left and right speakers. Press ◀ or ▶, select the desired level, and then press **ENTER**.
Range: 0~20
Default: 10

HDMI Audio Input

Select HDMI and PC audio input mode.
Default: HDMI

Basic Settings Menu

This menu is used to make initial set-up adjustments to the OSD (On-Screen Display) menu and other on-screen messages.

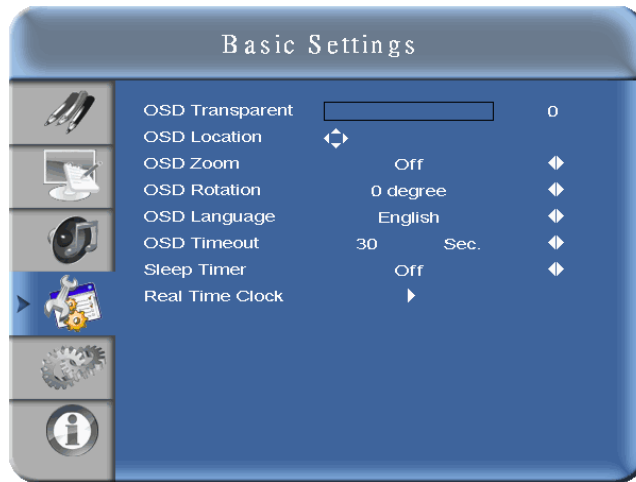

OSD Transparent

Set the menu transparency. Press ◀ or ▶ to select the desired level, and then press **ENTER**.

Range: 0~100

Default: 0

OSD Location

Adjust the menu location on the monitor (Up, Down, Left, Right).

OSD Zoom

Options: On, Off

Default: Off

OSD Rotation

Select the OSD Rotation. Press ◀ ▶ select the rotation.

Options: 0, 90, 180, 270

Default: 0 degree

OSD Language

Options: English and Chinese

Default: English

OSD Timeout

Options: 5~120

Default: 30

Sleep Timer

Set a period of time after which the monitor will switch to standby mode automatically. Press ◀ ▶ to select the desired time limit.

Options: Off, 15, 30, 45, 60, 90, 120 Min

Default: Off

Real Time Clock

Set date, and switch alarm on and off. Use ▲, ▼, ◀, ▶ to adjust these options.

Advanced Settings Menu



Auto Adjustment

Forces the monitor to reacquire and lock to the input signal. This is useful when the signal quality is marginal. Note: This feature does not continually reacquire the signal.

Options: No, Yes

Default: No

Image Position

Image location can be adjusted (Only VGA Mode).

Options: Up, Down, Left, Right

Phase

Range: 0~63 (Only VGA Mode)

Clocks

Range: 0~100 (Only VGA Mode)

Flesh Tone

Options: Off, Low, Medium and High (Only Video Mode)

Default: Off

Front LED

Options: On and Off

Default: On

IRFM

Creates slight frame motion to help avoid image retention.

Options: Off, 30 Min., 1 Hour, and 2 Hours

Default: Off

Baud Rate

Options: 115200, 38400, 19200, 9600

Default: 115200

Monitor ID

Options: 1~ 255

Default: 0

Light Sensor

Options: On and Off

Default: Off

Factory Reset

Restores all settings to their default.

Options: No, Yes

Default: No

System Status Menu

This read-only menu provides information on the active sources and the latest firmware version.

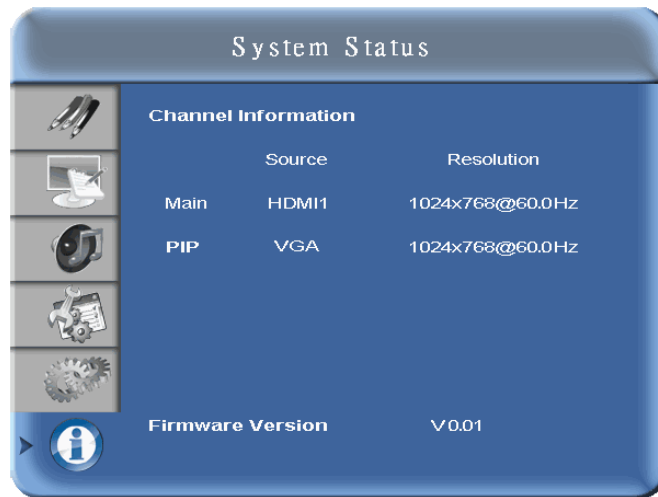

Default Setting

Item	Default Value
Brightness	80
Scheme	Users
Contrast	50
Color temp.	9300K
Language	English
Gamma	2.2
Over-scan	0%
Auto Scan	Off
Default input	HDMI 1
Power status	On
IRFM	Off
Baud rate	115200

Touch Operation (ST-HB65AVT Only)

1. Connect the signal cable with monitor, then turn on computer.
2. Connect the USB cable with monitor and computer.
3. Turn on the monitor (AC switch on).
4. Connect one side of USB cable (Type-B USB connector) on the monitor side. See below picture. (Check "Connection" section for exact location).

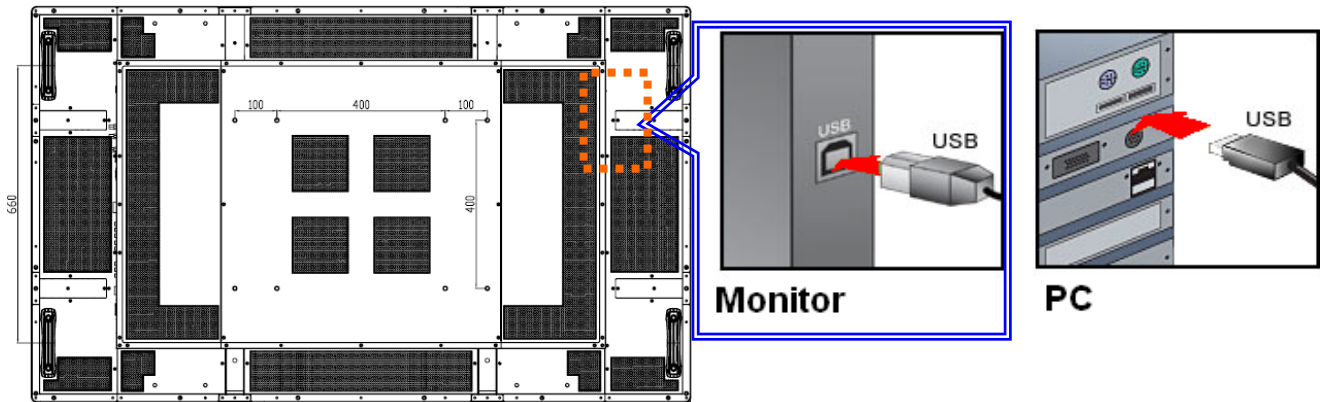

5. Connect the other side of USB cable (Type-A USB) to the USB port on computer. See picture below.

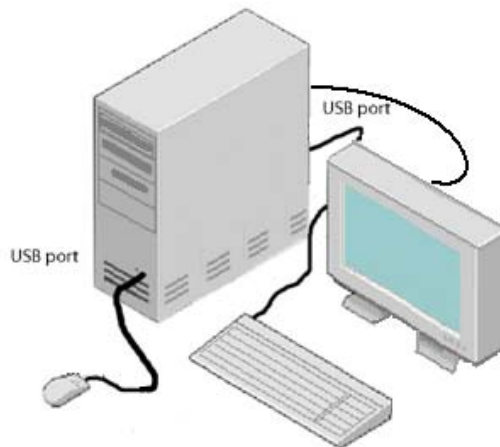

6. Wait for 5 seconds and the touch function is ready to go. It can be activated by pen, finger, or any other pointer.
7. This touch monitor is Microsoft Windows 7 compatible. In order to activate, go to http://www.nextwindow.com/nextwindow_support/windriver.html to download the latest driver. Follow the direction in the **NW Multitouch Device Driver Installation Guide** (part of the compressed file along with the driver) to install the driver.
8. Once the driver is installed, restart the PC and the touch function is ready to go with MS Windows 7.

9. 4-Point Calibration Procedure: (Note: no calibration is required for first time use, however, the touch panel might be required for calibration over time depends on the usage)

- i. Press the CAL button (illustration A) located next to the USB connector (see page33, item 4 for location) or press the "Scroll Lock" key (illustration B) on the keyboard 6 times.



(A)



(B)

- ii. Wait for the beep sound, and the cursor will move to near the upper left corner of the display automatically.
- iii. Place finger, gloved hand, or any other pointer on the cursor, and stay for 2 seconds (a beep sound will occur when the pointer is placed on the cursor). Then the cursor will move to near the upper right corner automatically.
- iv. Repeat the procedure of item III until all 4 points is calibrated. (see image below for the places where cursor appears).

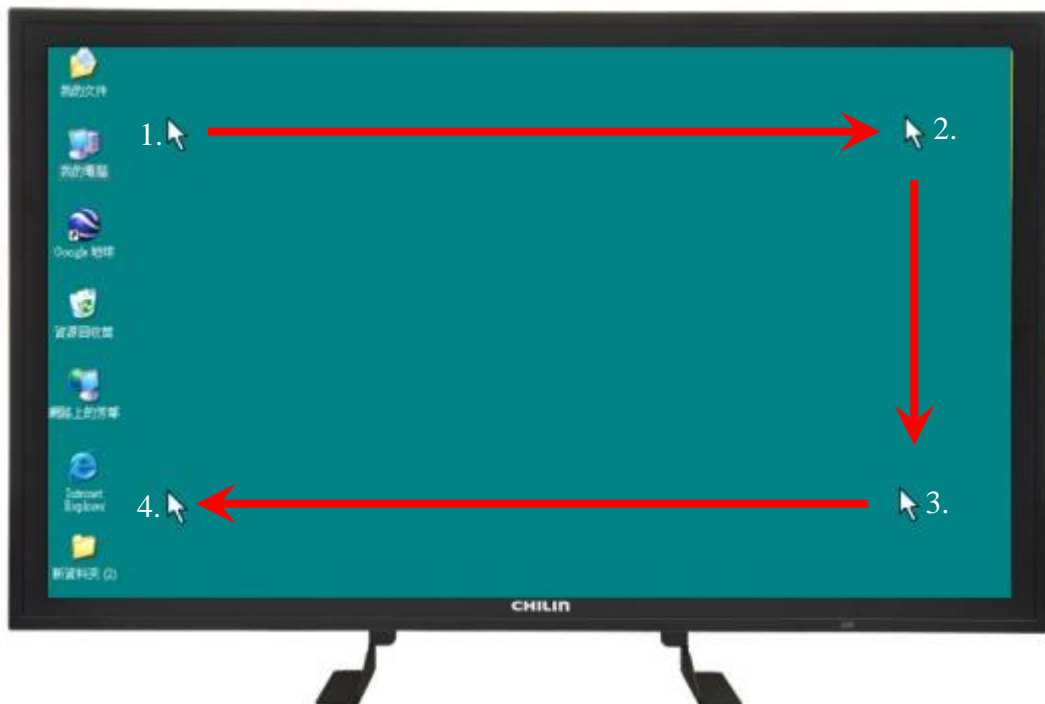

- v. The calibration is completed and the touch monitor is ready to be used now.

Supported Timing

Timing		fH (kHz)	fV (Hz)	Dot clock (MHz)	HDMI	VGA	Component	S-Video	Composite(AV)	DVI (AA)	HD-SDI (AA)	
VESA	VGA 640x480	31.469	59.94	25.175	v	v				v		
		37.861	72.809	31.5	v	v				v		
		37.5	75	31.5	v	v				v		
		43.269	85.008	36	v	v				v		
	SVGA 800x600	35.156	56.25	36	v	v				v		
		37.879	60.317	40	v	v				v		
		48.077	72.188	50	v	v				v		
		46.875	75	49.5	v	v				v		
		53.674	85.06	56.25	v	v				v		
	XGA 1024x768	48.363	60.004	65	v	v				v		
		56.476	70.069	75	v	v				v		
		60.023	75.029	78.75	v	v				v		
	WXGA1360x768	68.677	84.997	94.5	v	v				v		
		47.712	60.015	85.5	v	v				v		
	1280 x 720	44.444	59.98	64	v	v				v		
		44.772	59.86	74.5	v	v				v		
		56.456	74.78	95.75	v	v				v		
	1280 x 768	47.776	59.87	79.5	v	v				v		
		47.396	59.995	68.25	v	v				v		
		68.633	84.837	117.5	v	v				v		
	1280 x 800	49.306	59.91	71	v	v				v		
		49.702	59.81	83	v	v				v		
	SXGA	1152x864	67.5	75	108	v	v				v	
			63.981	60.02	108	v	v				v	
		1280x1024	79.976	75.025	135	v	v				v	
	SXGA+	1400 x 1050	91.146	85.024	157.5	v	v				v	
			64.744	59.95	101	v	v				v	
	1440 x 900		65.317	59.98	121.75	v	v				v	
55.469			59.901	88.75	v	v				v		
WSXGA+ 1680 x1050		55.935	59.88	106.5	v	v				v		
		64.674	59.98	119	v	v				v		
UXGA 1600 x 1200		65.29	59.954	146.25	v	v				v		
		75	60	162	v	v				v		
WUXA 1920 x 1200		66.587	59.93	138.5	v	v				v		
		74.038	59.95	154	v	v				v		
SDTV	NTSC	15.734	29.97	13.5	480i		v	v	v	480i	483i	
	PAL	15.625	25	13.5	576i		v	v	v	576i	576i	
EDTV	480p	31.5	60	27.03	v		v			v		
	576p	31.25	50	27	v		v			v		
HDTV	720p 1280x720	37.5	50	74.25	v		v			v	v	
		44.995	59.94	74.176	v		v			v	v	
		45	60	74.25	v		v			v	v	
	1080i 1920x1080	28.13	50	74.25	v		v			v	v	
		33.716	59.94	74.176	v		v			v	v	
		33.75	60	74.25	v		v			v	v	
	1080p 1920x1080	27	24	74.25	v						v	
		33.75	30	74.25							v	
		56.25	50	148.5	v		v			v	v	
		67.433	59.94	148.352	v		v			v	v	
		67.5	60	148.5	v		v		v	v		

V means supported the timing.
 480i means supported 480i@60Hz(YPbPr).
 576i means supported 576i@60Hz(YPbPr)

Specification

Item		Specification
LCD panel	Resolution	1920 x 1080 (HD monitor format)
	Brightness	500 cd/m ²
	Contrast Ratio	5000
	Response time (GTG)	5.5 ms
	Aspect Ratio	16:9
	Horizontal Sync.	Positive / Negative
	Vertical Sync.	Positive / Negative
Connectors	HDMI1, HDMI2, VGA(with PC Audio In) , ★ DVI(with PC Audio In), Component (with Audio L/R), S-Video (with Audio L/R – shared with Video), Video (with Audio L/R – shared with S-Video), SPDIF, RS232	
Scan Rate	Horizontal	31~91 KHz
	Vertical	56~85 Hz
Performance	Auto Adjust	Clock, Phase, H-Position and V-Position
	Screen Scaling	VGA/SVGA/XGA/WXGA/HD monitor Full Screen Display, WUXGA
	Power Management	VESA DPMS
	OSD Language	English and Chinese
Power Source	Power Input	AC 100V~240V
Power Consumption	Operation Mode (Typ.)	473 W
	Power Saving Mode (Typ.)	1W
	Input Frequency Range	50 - 60 Hz
	Rated Input Volt	AC 100-240V
Physical	Dimension (W×H×D)	ST-HB65AVX: 1567.6mm × 942.6mm × 155.7mm (61.7" x 37.1" x 6.1") ST-HB65AVT: 1567.6mm × 942.6mm × 171mm (61.7" x 37.1" x 6.7")
	Net Weight	ST-HB65AVX: 67.0 KG ST-HB65AVT: 85.0 KG
	Gross Weight w/ packing	ST-HB65AVX: 89.0 KG ST-HB65AVT: 107KG
Environment	Storage Temperature	Min -5°C ~ Max 50°C
	Operating Temperature	Min 5°C ~ Max 35°C
	Humidity	90% RH @40°C
Function	Plug and Play	DDC 2B Compliance
	RS232	D-Sub 9-pin / RJ-45 in&out
	OSD key	7 keys (⏻, SOURCE, ▶, ◀, ▲, ▼, MENU/EXIT)
	Wall mount	400 x400 ; 400 x600 VESA standard
Option	Speaker	Input 1Vp-p, Output: 10W/4Ω x2
Touch Function (65AVT)	Technology	Optical
	Method	Finger, gloved hand, or any other pointer
	Interface	USB (type B female)
	Transmittance	88%
	Operating System	Windows 98/NT/2000/XP/Vista/7 (driver required), Mac OS and Linux

★ Input connectors: DVI/IR out/Push terminal (speaker out) is available on 65AA Series only and HD-SDi is an option of the 65AA Series.

Troubleshooting

Before calling service personnel, please check the following chart for a possible cause to the trouble you are experiencing.

- ◆ Perform the adjustments according to page 13 “Operation The Monitor”
- ◆ If the problem you have experienced isn’t described below or you can’t correct the problem, stop using the monitor and call service personnel or your dealer.

Problem	Check these things
No Display	Ensure the power plug is installed correctly on both ends. Check the main power switch is set to “—” Check that source equipment is operating correctly. Check the input signal is compatible with this display.
The image is not centered	Check the input signal is compatible with this display.
The image is not locked correctly	Check the input signal is compatible with this display.
The remote control doesn’t work	Make sure the batteries fresh and are installed correctly. Ensure the remote is aimed at the IR sensor on the front of the display
The picture color looks poor	Check the picture settings. Reset the display. If you are using YUV terminals, make sure cables are correctly connected.

Compliance

FCC Compliance Statement:

This equipment has been tested and found to comply with the limits for a Class A digital device, pursuant to part 15 of the FCC Rules. These limits are designed to provide reasonable protection against harmful interference when the equipment is operated in a commercial environment. This equipment generates, uses, and can radiate radio frequency energy and, if not installed and used in accordance with the instruction manual, may cause harmful interference to radio communications. Operation of this equipment in a residential area is likely to cause harmful interference in which case the user will be required to correct the interference at their own expense.

Warning

This is class A products. In a domestic environment this product may Cause radio interference in which case the user may be required to take adequate measures.

This device complies with Part 15 of the FCC Rules. Operation is subject to the following two conditions : (1) this device may not cause harmful interference, and (2) this device must accept any interference received, including interference that may cause undesired operation.

CE

EN 55022 、 EN 61000-3-2 、 EN-61000-3-3
EN 55024 、 IEC61000-4
EN 60950 [Low-Voltage Directive (73/23/EEC)]

CHI LIN TECHNOLOGY CO., LTD.

Appendix I

◆ Moving Notice:

Moving the monitor requires at least two people. If not, it may drop and a serious injury may result. Moving/shipping the monitor, please hold the white handles.

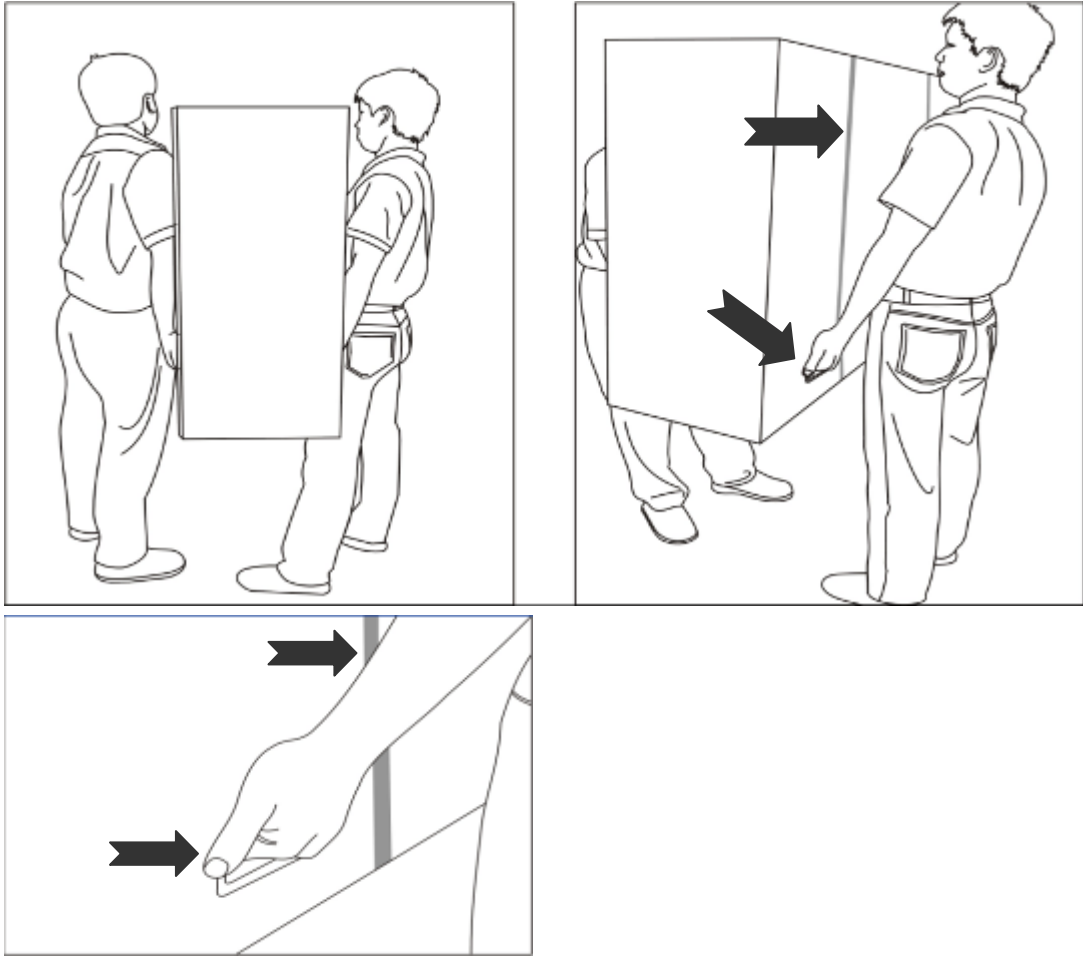

◆ Carrying Notice :

This monitor is heavy; please follow as below instruction, when you ready to carry the monitor. If not, it may cause an injury.

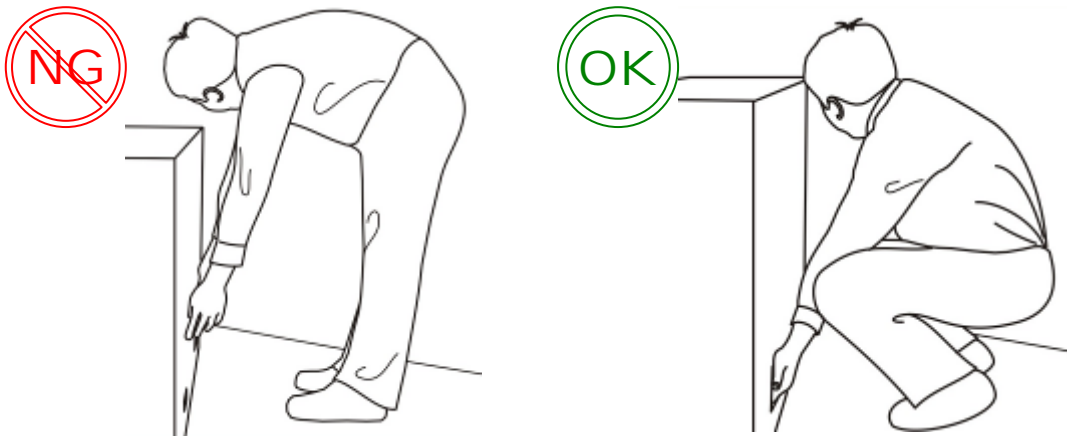

Appendix II

◆ Installing the table stand kit:

1. Place the monitor (LCD screen face down) on a flat, stable surface, which has been covered with a soft cloth. This will help prevent the monitor from being scratched.
2. Remove the screws (**M8*15 screw x2**) from the stand bracket at the back of the monitor.
3. Align the stand brackets with the mounting holes and attach the brackets to the monitor using the screws removed in Step 2.
4. **Caution: Longer screws will damage the monitor.**

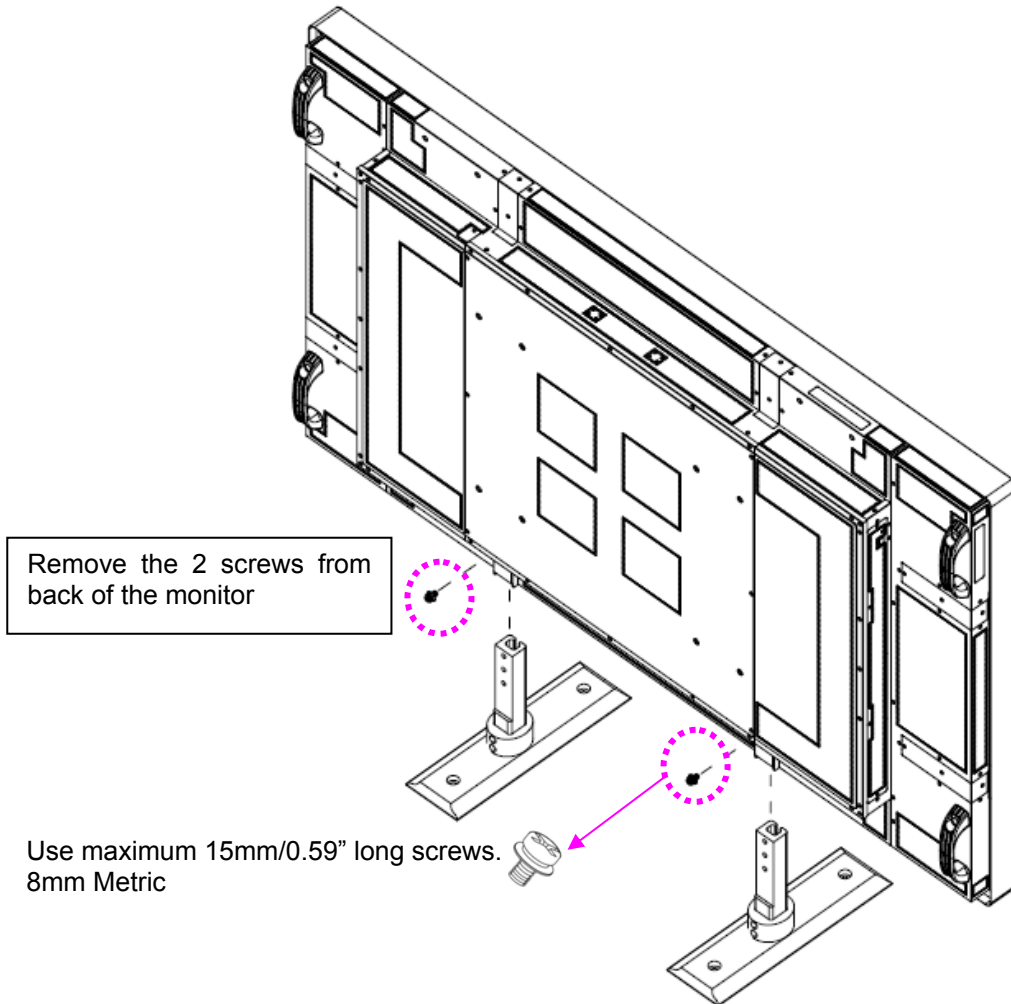

◆ **Installing a wall mount kit:**

1. Follow the manual instructions for the type of mount you have selected. Refer all servicing to qualified service personnel.
2. Moving the monitor requires at least two people.
3. Before installing, please make sure the wall is strong enough to hold the necessary weight of the display and the mount.

Step1. Keep the display facing the ground and place it on a flat object.

Step2. Remove the 8 screws (M8*15) from the back of the monitor.

Step3. Align the wall brackets with the mounting holes and attach the brackets to the monitor using the screws removed in Step 2.

Caution: Longer screws will damage the monitor.

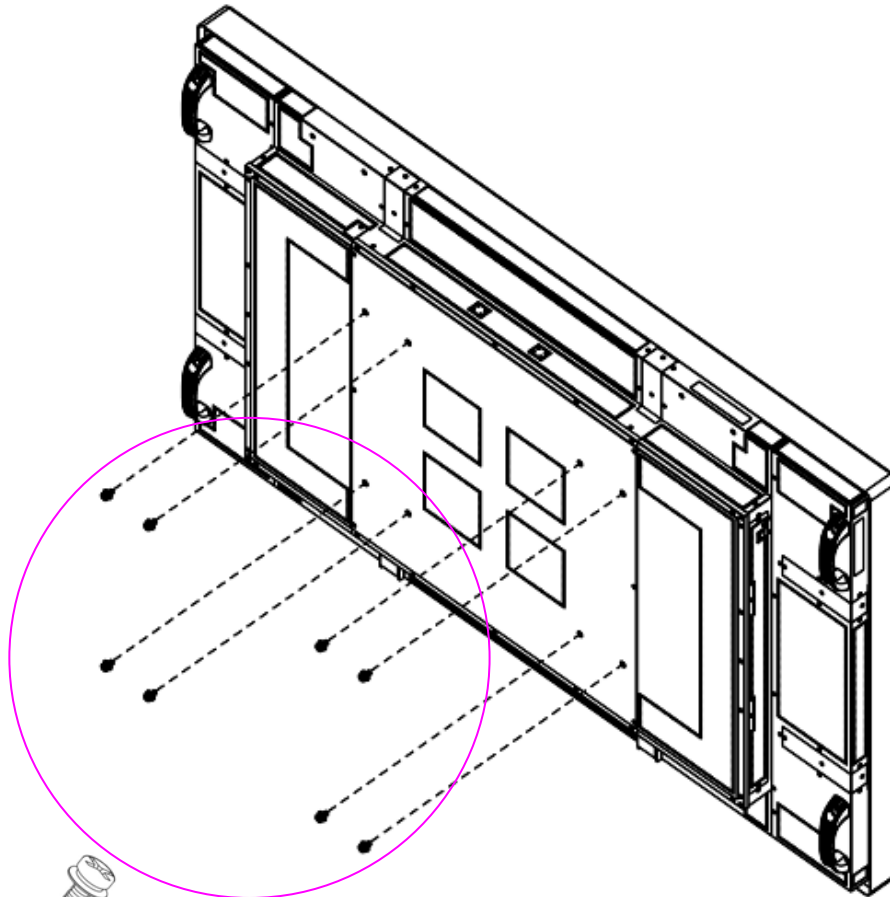

Use maximum 15mm/0.59" long screws.
8mm Metric

Appendix III Wall mounting safety Notes

1. Please make sure if the bracket is fixed to the solid wall / solid pillar for fear of falling due to heavy weight.

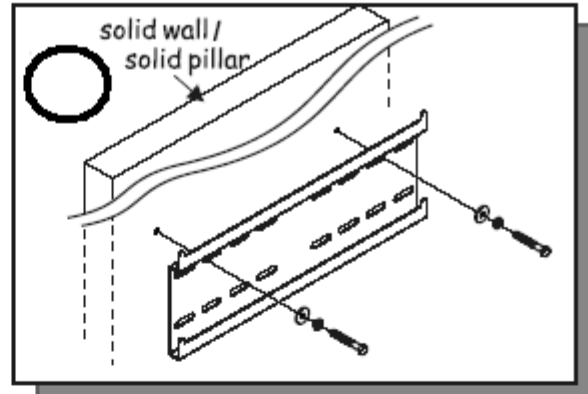
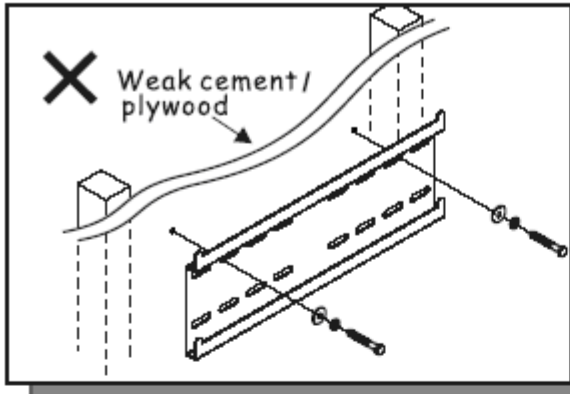

2. After assembling, please don't pull or shake violently.

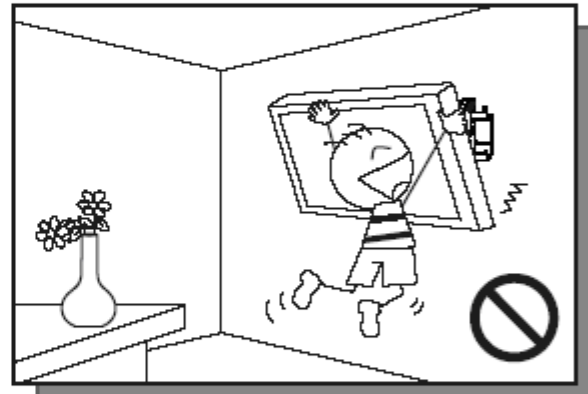
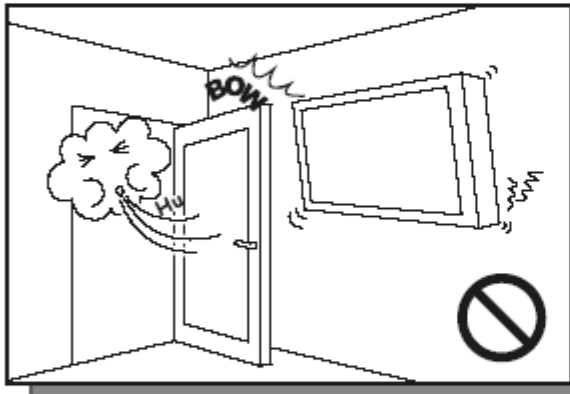

3. Please don't install the bracket directly under the sunshine or humidity / high temperature places for fear that the quality is effected.

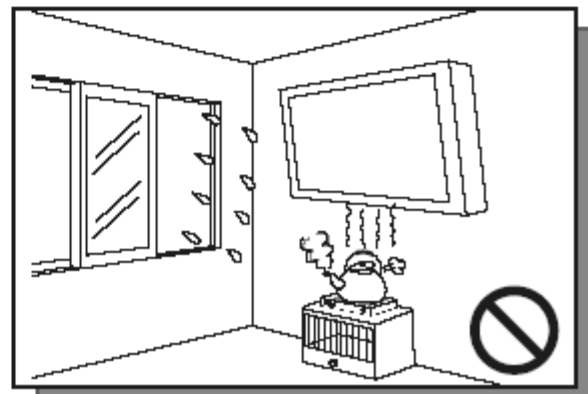
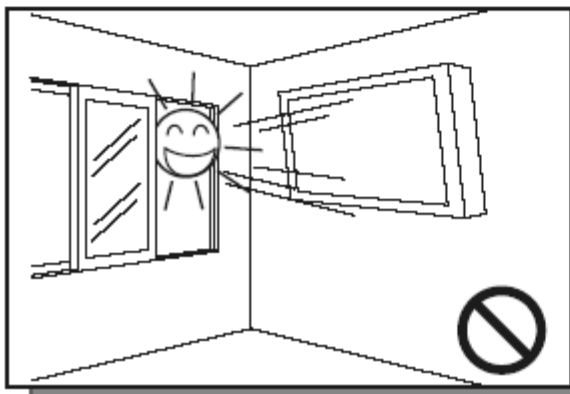

4.

Installing the brakcet over 10 cm from each wall side and being vertical to the ground is the suggested installing position.

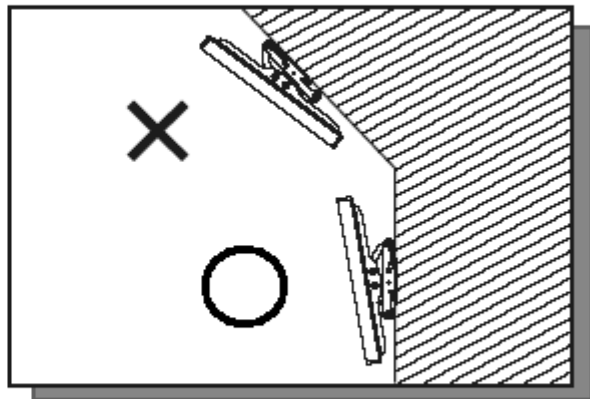
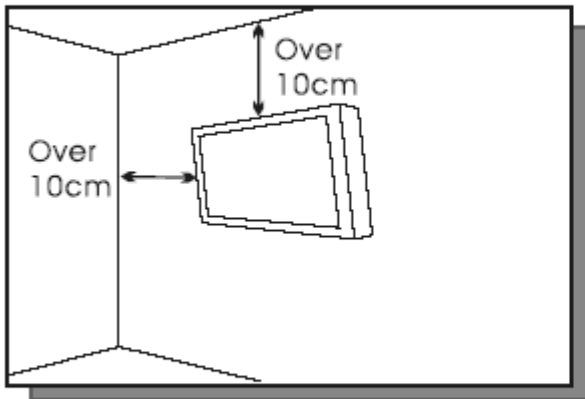

5.

Please make sure to hang on the mounting hooks firmly.

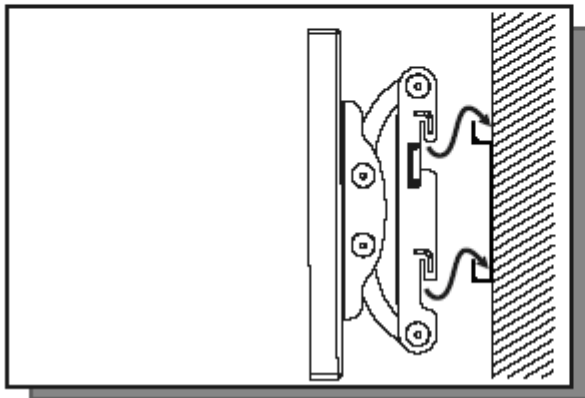

6.

The flat screen must be put in the mid of the bracket for fear of slope.

